

TRAVATO

TABLE OF CONTENTS

1 – INTRODUCTION

About this Manual	1-1
Safety Messages Used in this Manual	1-1
Pre-Delivery Inspection	1-2
Before Driving	1-2
Front Axle Tire Alignment	1-2
Headlight Alignment	1-2
Service and Assistance	1-2
Reporting Safety Defects	1-2
Occupant and Cargo Carrying Capacity Labels	1-3
Vehicle Certification Label	1-4
Specifications and Capacities	1-5
Owner and Vehicle Information	1-6

2 – SAFETY AND PRECAUTIONS

General Warnings	2-1
Driving Safety	2-2
Fuel and Propane Gas	2-2
Propane Gas Leaks	2-4
Propane Gas Leak Detector	2-4
Carbon Monoxide Warning	2-5
Carbon Monoxide Alarm	2-5
Smoke Alarm	2-6
Fire Extinguisher	2-6
Electrical	2-6
Loading	2-7
Maintenance	2-7
Roof and Ladders	2-7
Formaldehyde Information	2-8
Mold, Moisture, and Your Motorhome	2-8
Roadside Emergency	2-9
Jump Starting	2-10
Engine Overheat	2-10

3 – DRIVING YOUR MOTORHOME

Seats – Driver/Co-Pilot	3-1
Seat Belts	3-2
Keys	3-3
Remote Keyless Entry	3-3
Hazard Warning Flashers	3-3
Air Conditioner/Heater – Automotive (Dash)	3-3
Windshield Blinds	3-3

Table Of Contents

Radio – In-Dash	3-5
Radio In-Dash/Rearview Monitor System	3-5
Engine Cooling System	3-5
Lights	3-5
Tires	3-6
Suspension Alignment and Tire Balance	3-6
High performance wheels	3-6

4 – APPLIANCES AND SYSTEMS

Refrigerator	4-1
Range Top (Electric)	4-1
Microwave Oven	4-2
Microwave/Convection Oven	4-2
OnePlace® Systems Monitor Panel	4-2
Solar Charge Panel	4-4
Power Control System (PCS)	4-5
Heating System – Furnace and Indirect Water Heating	4-6
Roof Air Conditioning System WITH BLUETOOTH CONTROL	4-7
Air Conditioner Filter	4-7

5 – PROPANE GAS

Propane Gas Supply	5-1
Propane Accessory Connection	5-3
Safe Use of the Propane Gas System	5-4
Propane Gas Warnings and Precautions	5-4
Propane Gas Pressure Regulator	5-5
Propane Vaporization in Cold Weather	5-6

6 – ELECTRICAL

Electrical Cautions	6-1
Electrical System – House 120-Volt AC	6-1
Power Cord – External (Detachable)	6-1
Inverter/Charger Unit – 3600W	6-2
Power Center	6-3
Circuit Breakers – House 120-Volt AC	6-4
Electrical Outlets – House 120-Volt AC	6-5
Ground Fault Circuit Interrupter	6-5
Electrical System – House DC	6-5
Battery Access	6-6
Chassis Battery Care	6-6
Circuit Breakers and Fuses	6-7
Pure3 DC System (Volta)	6-9

7 – PLUMBING

Fresh Water System	7-1
Exterior utility light switch	7-2
Eco-hot system	7-2

Table Of Contents

Water Pump	7-2
Cold Water Filter	7-4
Disinfecting Your Fresh Water System	7-4
Shower Valve pressure bleed-off	7-7
Sink – Lavatory	7-7
Exterior Shower/Wash Stations	7-8
Toilet	7-8
Waste Water System (Model 59GL)	7-8
Waste Water System (Model 59KL)	7-11
Tank Heaters	7-14
Waterline and Tank Drain Valves	7-14
Winterizing Procedure	7-15
Water System Drain Locations	7-21

8 – ENTERTAINMENT

TV – (Swing-Out)	8-1
TV – Swivel	8-1
Audio/Video System Basic Operation	8-2
TV Antenna – Digital	8-2
TV Signal Amplifier	8-2
Cable TV Connection	8-3
Exterior Cable TV – 12V Connection	8-3
Audio/Video System Connection	8-3
Access Port (Roof)	8-4

9 – FURNITURE AND SOFTGOODS

Sleeping Facilities	9-1
Dinette table	9-1
Dinette table (portable)	9-1
Bed	9-2
Bed – Deluxe Sleep System	9-3
Window Shades/Screens	9-4
Window Shades	9-4
Wood Furniture and Cabinetry	9-5

10 – MAINTENANCE AND STORAGE

Sealants – Inspection and General Information	10-1
Roof	10-1
Undercarriage	10-1
Exterior Automotive Paint Finish	10-2
Exterior Graphic Care	10-4
Plastic Parts – Cleaning	10-5
Exterior Lights	10-5
Interior Soft Goods	10-5
Cabinetry – Cleaning	10-7
Decorative Vinyl Wall Paneling – Cleaning	10-7

Table Of Contents

Tables and Countertops	10-7
Solid Surface Countertop – Corian®	10-8
Sink – Stainless Steel	10-8
High Gloss and matte cleaning	10-9
Range and Refrigerator	10-9
Vinyl Flooring	10-9
Bathroom	10-10
Doors and Mirrors	10-11
Windows	10-11
Vehicle Storage – Preparation	10-11
Vehicle Storage – Removal	10-12
Chassis Service and Maintenance	10-12
Motorhome Maintenance Chart	10-13

11 – MISCELLANEOUS

Loading the Vehicle	11-1
Weighing Your Loaded Vehicle	11-1
Car or Trailer Towing	11-3
Trailer Wiring Connector	11-4
Towing Guidelines	11-4
Window – Sliding Door	11-5
Windows	11-5
Power Roof Ventilator	11-6
Power Roof Ventilator	11-7
Awning – Power with bluetooth	11-7
Accent LED Running Board Lights	11-9
Screen Door	11-9
Bike Rack	11-10
Ladder	11-10
Luggage Rack	11-12
Shower Curtain Pawn Magnets	11-12
Effects of Prolonged Occupancy	11-12

SECTION 1 – INTRODUCTION

Congratulations! We welcome you to the exciting world of motorhome travel and camping. You will find it convenient and enjoyable to have all the comforts of home and still enjoy the great outdoors wherever you choose to go.

Before sliding into the driver's seat, please become familiar with operations and features. In addition, spend some time with the dealer when you take delivery to learn all you can about your new motorhome.

ABOUT THIS MANUAL

This operator's manual was prepared to aid you in the proper care and operation of the vehicle and equipment.

Please read this manual completely to understand how everything in your motorhome works before taking it on its "maiden voyage". In addition, please become familiar with the New Vehicle Limited Warranty.

NOTE: This manual describes many features of your motorhome and includes instructions for its safe use.

This manual, including photographs and illustrations, is of a general nature only.

Some equipment and features described or shown in this manual may be optional or unavailable on your model.

Because of Winnebago Industries[®], continuous program of product improvement, it is possible that recent product changes and information may not be included.

The instructions included in this manual are intended as a guide, and in no way extend the responsibilities of Winnebago Industries beyond the standard written warranty as presented in this manual.

The descriptions, illustrations, and specifications in this manual were correct at the time of printing. We reserve the right to change specifications or

design without notice, and without incurring obligation to install the same on products previously manufactured.

The materials in your InfoCase contain warranty information and operating and maintenance instructions for the various appliances and components in your motorhome.

NOTE: Many of the instruction sheets and manuals for the various appliances and components have been incorporated into the Operator's Manual Supplement for your convenience.

Please read the FAQ in Section 1 of the Operator's Manual Supplement for more details.

Throughout this manual, frequent references are made to the vehicle chassis manual that is provided by the manufacturer of the chassis on which this motorhome is built.

Consult the chassis manual for operating, safety, and maintenance instructions pertaining to the chassis section of the motorhome.

SAFETY MESSAGES USED IN THIS MANUAL

Throughout this manual, certain items are labeled Danger, Warning, Caution, Notice, or Note. These terms alert you to precautions that may involve damage to your vehicle or a risk to your personal safety. Read and follow them carefully.



DANGER indicates a hazardous situation which, if not avoided, will result in death or serious personal injury.

SECTION 1 – INTRODUCTION



WARNING

WARNING indicates a hazardous situation which, if not avoided, could result in death or serious personal injury.



CAUTION

CAUTION indicates a hazardous situation which, if not avoided, could result in minor or moderate personal injury.

NOTICE

NOTICE is used to address practices not related to personal injury.

NOTE: A “Note” is not necessarily safety-related, but indicates a recommendation or special point of information that could assist in understanding the use or care of a feature item.

PRE-DELIVERY INSPECTION

This motorhome has been thoroughly inspected before shipment. Your dealer is responsible for performing a complete pre-delivery inspection of the chassis and all motorhome components.

As a part of the pre-delivery inspection procedure, the dealer is responsible for road testing the motorhome, noting, and correcting any problems before delivery.

BEFORE DRIVING

Familiarize yourself with State/Province and local regulations before traveling. There are many local rules that may impact your travels.

FRONT AXLE TIRE ALIGNMENT

We recommend that you have the front suspension and steering alignment checked and adjusted after you have fully loaded the vehicle according to your needs. Thereafter, have alignment inspected periodically to maintain vehicle steering performance and prevent uneven tire wear.

HEADLIGHT ALIGNMENT

Headlights on this motorhome were aligned at the factory in an unloaded state. We recommend you have the high and low beam alignment checked after fully loading the vehicle to your needs. Thereafter, have the alignment inspected periodically to maintain visibility.

SERVICE AND ASSISTANCE

Your dealer will be glad to provide any additional information you need, as well as answer any questions you might have about operating the equipment in your motorhome. When it comes to service, remember that your dealer knows your vehicle best and is interested in your satisfaction. Your dealer will provide quality maintenance and any other assistance that you may require during your ownership of this vehicle.

If you need warranty repairs while traveling, you may take your vehicle to any authorized Winnebago Industries® dealership and request their assistance.

See the Service Dealer Directory in your InfoCase.

REPORTING SAFETY DEFECTS

If you believe that your vehicle has a defect which could cause a crash or could cause injury or death, you should immediately inform the National Highway Traffic Safety Administration (NHTSA) in addition to notifying Winnebago Industries, Inc.

If NHTSA receives similar complaints, it may open an investigation, and if it finds that a safety defect exists in a group of vehicles, it may order a recall and remedy campaign. However, NHTSA cannot become involved in individual problems between you, your dealer, or Winnebago Industries, Inc.

To contact NHTSA, you may either call the Vehicle Safety Hotline toll-free at: 1-888-327-4236; (TTY: 1-800-424-9153) or go to <http://www.safercar.gov> or write to:

Administrator, NHTSA
1200 New Jersey Avenue S.E.
Washington, D.C. 20590

You can also obtain other information about motor vehicle safety at <http://www.safercar.gov>.

If any weight exceeding 45.4 kg (100 lbs.) is added to your motorhome between final vehicle certification and first retail sale, the occupant and cargo carrying capacity must be corrected and a label similar to the one shown below will be affixed inside your motorhome.



OCCUPANT AND CARGO CARRYING CAPACITY LABELS

The following labels are affixed on the driver's door jamb. The first label contains vehicle occupant and cargo carrying capacity along with the number of seat belt positions in the vehicle. The second label also provides the weight of a full load of water and advises that this weight, along with the tongue weight counts as cargo.

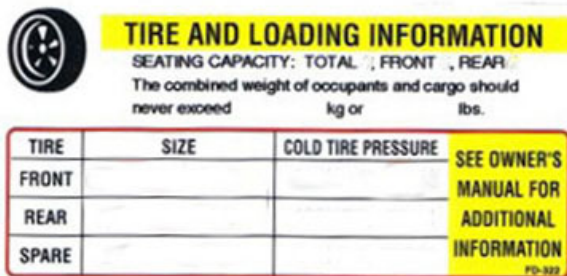

CAUTION:
A full load of water equals kg or lbs of cargo @ 1 kg/L (8.3 lb/gal) and the tongue weight of a towed trailer counts as cargo.

SECTION 1 – INTRODUCTION

VEHICLE CERTIFICATION LABEL

This label is affixed to the lower driver side armrest panel, driver door, or the driver side door jamb, depending on model. It contains vehicle identification numbers and other important reference information.

THIS VEHICLE WAS ALTERED BY:					
WINNEBAGO INDUSTRIES, INC.					
IN ¹ mm / yyyy AND AS ALTERED IT CONFORMS TO ALL APPLICABLE FEDERAL MOTOR VEHICLE SAFETY STANDARDS AFFECTED BY THE ALTERATION AND IN EFFECT IN mm/yyyy ²					
SERIAL NO	³	VIN	⁴	TYPE	⁵ MPV COLOR ⁶
XXXX CHAS	15W-XXXX	2017 PASEO		BU848P	168123-A
		⁷		⁸	

EXPLANATION OF DATA

1. Month and year vehicle was altered at Winnebago Industries®.
2. Month and Year vehicle was completed by the chassis manufacture.
3. Serial Number: This is the serial number assigned to the completed vehicle by Winnebago Industries.
4. Vehicle Identification Number (VIN): This number identifies the chassis on which the motorhome is built. The 10th digit of the VIN designates the chassis model year (J=2018, K=2019, L=2020, etc.). This information is useful when ordering chassis repair parts.
5. Type: States the NHTSA designated usage classification for your motorhome. MPV signifies a Multi-purpose Passenger Vehicle.
6. Color: Signifies the color code number of the decor used throughout the vehicle. This number is necessary for ordering replacement cushions, curtains, carpet, etc.
7. Winnebago® model year and series/family name.
8. Model: Lists the Winnebago product model number of your vehicle.

SPECIFICATIONS AND CAPACITIES

	59GL	59KL
	Standard RAM ProMaster 3.6L Van Chassis	Standard RAM ProMaster 3.6L Van Chassis
Feature Number	1MU	1MU
Length	21'	21'
Exterior Height ¹	9' 4"	9' 4"
Exterior Width	6' 8.7"	6' 8.7"
Awning Length	13'	13'
Interior Height	6' 3"	6' 3"
Interior Width	6' 1.62"	6' 1.62"
Freshwater Tank Capacity ²	18 gal.	18 gal.
Water Heater Capacity	2.6 gal.	2.6 gal.
Holding Tank Capacity - Black ²	11 gal.	12 gal.
Holding Tank Capacity - Gray ²	14 gal.	12 gal.
Propane Capacity ³	24.957 lbs.	24.957 lbs.
Wheelbase	159"	159"
GVWR	9,350 lbs.	9,350 lbs.
GAWR - Front	4,629 lbs.	4,629 lbs.
GAWR - Rear	5,291 lbs.	5,291 lbs.
GCWR ⁴	11,500 lbs.	11,500 lbs.
Fuel Capacity	24 gal.	24 gal.

Notes:

All information is based upon the most recent data available. Visit the Winnebago Industries, Inc. web page – www.winnebagoind.com – for the most current product information.

¹ The height of each model is measured to the top of the tallest standard feature and is based on the curb weight of a typically equipped unit. The actual height of your vehicle may vary by several inches depending on chassis or equipment variations. Contact your dealer for further information.

² Capacities are based on measurements prior to tank installation. Slight capacity variations can result upon installation.

³ Capacities shown are the tank manufacturer's listed water capacity (W.C.). Actual filled propane capacity is 80% of listing due to overfilling prevention device on tank.

⁴ Actual towing capacity is dependent on your particular loading and towing circumstances which includes the GVWR, GAWR, and GCWR as well as adequate trailer brakes. Refer to the chassis operator's manual of your motor home for further towing information.

**SECTION 1 –
INTRODUCTION**

OWNER AND VEHICLE INFORMATION

OWNER INFO

Owner's Name(s) _____

Address _____

VEHICLE INFORMATION

Motorhome Model Number _____

Motorhome Serial Number _____

Chassis Vehicle Identification No. (VIN) _____

Vehicle Mileage at Delivery _____

Selling Dealer Name _____

Address _____

YOUR WINNEBAGO INDUSTRIES® DEALER /SERVICE CENTER

Name _____

Address _____

Contact _____ Phone _____

CHASSIS SERVICE CENTER

Name _____

Address _____

Contact _____ Phone _____

RV INSURANCE POLICY

Company _____

Policy Number _____

Agent _____ Phone _____

SECTION 2 – SAFETY AND PRECAUTIONS



GENERAL WARNINGS

- Only seats equipped with seat belts are to be occupied while the vehicle is moving.
- Make sure all passengers have seat belts fastened. Lap belts should fit low on the hips and upper thighs. The shoulder belt should be positioned snug over the shoulder.
- For pregnant women: Never place the shoulder belt behind your back or under your arm. Adjust the lap belt across your hips/pelvis, and below your belly. Place the shoulder belt across your chest (between your breasts) and away from your neck.
- Child restraints should be installed properly according to manufacturer's instructions. See "Child Restraints".
- All moveable or swiveling seats should be placed and locked in travel position while the vehicle is moving.
- Never let passengers stand or kneel on seats while the vehicle is moving.
- Sleeping facilities are not to be utilized while vehicle is moving.
- Examine the escape window and be familiar with its operation.
- Inspect the fire extinguisher monthly for proper charge and operating condition. This should also be done before beginning a vacation or any extended trip.



WARNING

Operating, servicing and maintaining this vehicle can expose you to chemicals including engine exhaust, carbon monoxide, phthalates, and lead, which are known to the State of California to cause cancer and birth defects or other reproductive harm. To minimize exposure, avoid breathing exhaust, do not idle the engine except as necessary, service your vehicle in a well-ventilated area and wear gloves or wash your hands frequently when servicing your vehicle. For more information go to www.P65Warnings.ca.gov/passenger-vehicle.



SECTION 2 – SAFETY AND PRECAUTIONS

DRIVING SAFETY



WARNING

This motorhome has been designed, manufactured and tested with concern for the protection of its occupants. We recommend you perform the following inspections for your safety and the safety of your passengers before starting your vehicle.

1. **LP GAS SYSTEM** - Turn off the Main Tank Shutoff Switch for traveling. See *Section 5 - Propane Gas in this manual for switch locations.* Test for leaks upon arrival at destination before lighting pilots.
2. **WHEELS** - Inspect for damage and check lug nuts for tightness.
3. **TIRES** - Inspect for wear and damage and check for recommended air pressure.
4. **LIGHTING** - Test for proper operation of all interior and exterior lights including dash lights, headlights, tail lights, brake lights, clearance lights, and turn signals.
5. **EXITS** - Inspect release mechanism on emergency exit window, test both locks on main entrance door for ease of operation and instruct passengers how to use both means of exit.
6. **SEAT BELTS** - Direct passengers to designated seats, be certain swivel seats are locked into position, and require use of a seat belt. See operator's manual for occupancy and weight restrictions.
7. **APPLIANCES** - Turn off and latch or lock doors where provided.
8. **LOOSE PARCELS** - Store securely.
9. **UTILITY SUPPLY LINES** - Disconnect all electrical, sewer and water lines and secure properly.

Read your motorhome and chassis owner's manual for further precautions.

- Do not operate the cruise control on icy or extremely wet roads, winding roads, in heavy traffic, or in any other traffic situation where a constant speed cannot be maintained.
- Use care when accelerating or decelerating on a slippery surface. Abrupt speed changes can cause skidding and loss of control.
- Driving through water deep enough to wet the brakes may affect stopping distance or cause the vehicle to pull to one side. Check brake operation in a safe area to be sure they have not been affected. Never operate any vehicle if a difference in braking efficiency is noticeable.
- Adverse weather conditions and extremes in terrain may affect handling and/or performance of your vehicle. Refer to the chassis manual for complete and related information on driving your vehicle.
- Doors - Verify all interior and exterior doors are shut and/or stowed and latches are in place where provided.

FUEL AND PROPANE GAS



DANGER

All pilot lights, appliances, and their ignitors (see operating instructions) shall be turned off before refueling of motor fuel tanks and/or propane containers. Can cause ignition of flammable vapors, which can lead to a fire or explosion and result in death or serious injury.

- Do not attempt to adjust the driver's seat while the vehicle is moving.
- Do not adjust tilt steering in a moving vehicle.



 **WARNING**

Do not fill propane container(s) to more than 80 percent of capacity. A properly filled container contains approximately 80 percent of its volume as liquid propane. Overfilling propane container(s) can result in uncontrolled propane flow, which could lead to a fire or explosion and result in death or serious injury.

 **WARNING**

Do not place propane cylinders inside the vehicle. Propane cylinders are equipped with safety devices that relieve excessive pressure by discharging propane to the atmosphere. Propane gas is highly flammable. Can lead to a fire or explosion and result in death or serious injury.

- Do not place or store gasoline or other flammable liquid containers inside the vehicle.
- All pilot lights must be extinguished and appliances turned off while refilling the fuel tank or propane gas tank.
- Never smoke while refilling vehicle fuel tank or propane gas tank.
- Never use an open flame to test for propane gas leaks. Replace all protective covers and caps on propane system after filling. Make sure valve is closed and the door is latched securely.
- Never connect natural gas to the propane gas system.
- **Do not** turn burner controls to “On” and allow gas to escape before using ignitor or lighting a match.

- Portable fuel-burning equipment, including wood and charcoal grills and stoves shall not be used inside the recreational vehicle. The use of this equipment inside the recreational vehicle may cause fires or asphyxiation.
- Propane gas regulators must always be installed with the diaphragm vent facing downward. Regulators are equipped with a protective cover. Make sure that the regulator vent faces downward and that the cover is kept in place to minimize vent blockage, which could result in excessive gas pressure causing fire or explosion.
- The following warning label is located in the cooking area to remind you to provide an adequate supply of fresh air for combustion.

 **DANGER**

Do not use gas cooking appliances for comfort heating. Can lead to carbon monoxide poisoning, which can lead to death or serious injury.

 **WARNING**

Gas cooking appliances need fresh air for safe operation.
Before operating:
Open vents or windows slightly or turn on exhaust fan prior to using cooking appliance. Gas flames consume oxygen, which should be replaced to ensure proper combustion. Improper use can result in death or serious injury.

Unlike homes, the amount of oxygen supply is limited due to the size of the recreational vehicle, and proper ventilation when using the cooking appliance(s) avoids dangers of asphyxiation. It is especially important that cooking appliances not be used for comfort heating, as the danger of



SECTION 2 – SAFETY AND PRECAUTIONS

asphyxiation is greater when the appliance is used for long periods of time. Failure to comply could result in death or serious injury.

PROPANE GAS LEAKS

Check propane gas system for leaks yearly, or as necessary.

The following label is located in the vehicle near the range area. If you smell gas within the vehicle, quickly and carefully perform the procedures listed.



Propane Gas Leak Detector



DANGER

IF YOU SMELL PROPANE

1. Extinguish any open flames and all smoking materials.
2. Shut off the propane supply at the container valve(s) or propane supply connection.
3. Do not touch electrical switches.
4. Open doors and other ventilating openings.
5. Leave the area until odor clears.
6. Have the propane system checked and leakage source corrected before using again.

Ignition of flammable vapors could lead to a fire or explosion and result in death or serious injury.



WARNING

EXPLOSION HAZARD: DO NOT use an open flame to test for gas leaks. When testing for gas line leaks with a soapy water solution, **DO NOT** use a detergent containing ammonia or chlorine. These substances may generate a chemical reaction causing corrosion to gas lines, resulting in dangerous leak conditions. Death or serious injury can result.

PROPANE GAS LEAK DETECTOR

Your motorhome is equipped with a Propane Gas Leak Detector, similar to the one shown below. The leak detector sounds an alarm if an unsafe amount of propane gas is present inside the motorhome.

Power Connection

The Propane Gas Leak Detector is powered by the house battery. If the Pure³ system is deactivated, the alarm will not work. The Propane Gas Leak Detector fuse or circuit breaker is located in the 12-volt house electrical load center.

Because the Propane Gas Leak Detector is connected to the house battery, it is always drawing a small amount of current. Even though this current draw is slight, it could drain the house battery during storage periods when the house battery will not be charged regularly by the engine or shoreline.

Replacement

When replacing this alarm, we recommend replacing only with the same model, or with one that is also listed for RV application. We recommend obtaining a replacement from your Winnebago Industries® dealer.



Further Information

See the manufacturer’s user guide provided in your InfoCase for further instructions.

CARBON MONOXIDE WARNING

<p>WARNING</p>
<p>Avoid inhaling exhaust gases, as they contain carbon monoxide, which is a colorless, odorless, and poisonous gas. Death or serious injury can result.</p>

The best protection against carbon monoxide entry into the vehicle body is a properly maintained engine exhaust and ventilation system. It is recommended that the exhaust system and body be inspected by a qualified motorhome service center:

- Each time the vehicle is serviced for an oil change.
- Whenever a change in the sound of the exhaust system is noticed.
- Whenever the exhaust system, underbody, or rear of the vehicle is damaged.

To allow proper operation of the vehicle’s ventilation system, keep front ventilation inlet grill clear of snow, leaves, or other obstructions at all times. **DO NOT OCCUPY A PARKED VEHICLE WITH ENGINE RUNNING FOR AN EXTENDED PERIOD.**

Do not run engine in confined areas, such as a garage, except to move vehicle into or out of the area.

CARBON MONOXIDE ALARM

Your motorhome is equipped with a Carbon Monoxide (CO) Alarm, which has a sensor that is designed to detect toxic carbon monoxide gas fumes resulting from incomplete combustion of fuel. It will detect CO gas from any combustion

source such as the furnace, gas range/oven, water heater, refrigerator, chassis engine, and electric generator engine.

To reduce the risk of carbon monoxide poisoning, test this alarms operation after the motorhome has been in storage, before each trip, and at least once per week during use by pressing the Test/Reset button on the alarm.



Carbon Monoxide Alarm

<p>WARNING</p>
<p>Failure to replace this product by the “REPLACE BY DATE” printed on the alarm cover may result in death by Carbon Monoxide poisoning.</p>

Replacement

When replacing this alarm, we recommend replacing only with the same model, or with one that is also listed for RV application. We recommend obtaining a replacement from your Winnebago Industries® dealer.

Further Information

Please read the information provided by the manufacturer, which is included in your InfoCase for further information.



SECTION 2 – SAFETY AND PRECAUTIONS

SMOKE ALARM

Your motorhome is equipped with a Smoke Alarm (located on the ceiling in the lounge area.) The Smoke Alarm is powered by a 9-volt battery and has a sensor that is designed to detect smoke.



Smoke Alarm

The following label is affixed to the Smoke Alarm.

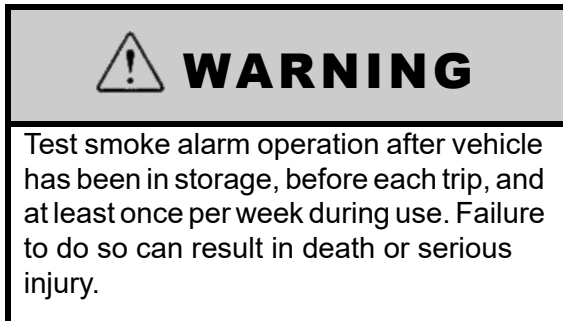

Replacement

When replacing this alarm, we recommend replacing only with the same model, or with one that is also listed for RV application. We recommend obtaining a replacement from your Winnebago Industries® dealer.

Expiration and Further Information

See the manufacturer’s information in your InfoCase for smoke alarm expiration and further instructions.

FIRE EXTINGUISHER

A dry chemical Fire Extinguisher is located near the sliding entrance door.

We recommend that you become thoroughly familiar with the operating instructions displayed on the side of the Fire Extinguisher and in the information supplied in your InfoCase.

We also recommend that you inspect the Fire Extinguisher for proper charge at least once a month in accordance with National Fire Protection Association (NFPA) recommendations as stated on the label.

If the extinguisher is past its expiration date or charge is insufficient, the Fire Extinguisher must be replaced.

NOTICE
Do not test the fire extinguisher by discharging it. Partial discharge can cause leakage of pressure or contents, which would render the unit inoperative when needed. When using the fire extinguisher, aim the spray at the base of the fire.

Replacement

If for any reason you must replace the Fire Extinguisher, the replacement must be the same type and size as the one originally supplied in your motorhome. We recommend obtaining a replacement only from your Winnebago Industries® dealer or a reliable RV parts supplier.

ELECTRICAL

- Careless handling of electrical components can be fatal. Never touch or use electrical components or appliances while feet are bare, while hands are wet, or while standing in water or on wet ground.



- Improper grounding of the vehicle can cause personal injury. Do not plug the utility power cord into an outlet which is not grounded and do not adapt the plug to connect to a receptacle for which it is not designed.
- Do not attach an extension cord to the utility power cord.
- Do not use any electrical device that has had the ground pin removed.
- Avoid overloading electrical circuits. Replace fuses or circuit breakers with those of the same size and amperage rating only. Never use a higher rated fuse or breaker.
- Use caution when handling or working near electrical storage batteries. Always remove jewelry and wear protective clothing and eye covering. Avoid creating sparks.
- Refer to Pure³ DC System (Volta) in *Section 6 - Electrical* for safety precautions.
- Always release the air prior to getting under the vehicle (if equipped).
- Do not mix different construction types of tires on the vehicle, such as radial, bias, or belted tires, as vehicle handling may be affected. Replace tires with exact size, type, and load range.
- Refer to the chassis manual for complete maintenance precautions and recommendations.

ROOF AND LADDERS

-If Equipped

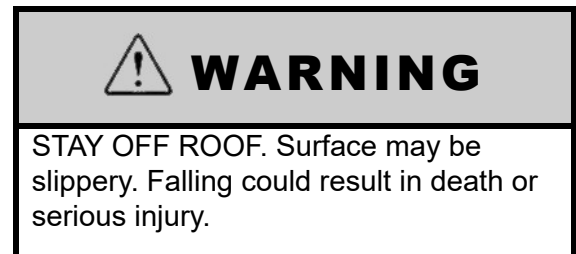

The ladder on your motorhome is provided for limited access to the roof.

For your safety, it is not recommended that you store or carry items on the roof.

Before Using the Ladder

LOADING

- Store or secure all loose items inside the motorhome before traveling. Possible overlooked items such as canned goods or small appliances on the countertop, cooking pans on the range, or free-standing furniture items can become dangerous projectiles during a sudden stop.
- Be aware of GVWR, GAWR, and individual load limit on each tire or set of duals (See “Loading the Vehicle” in *Section 11 - Miscellaneous*).
- Never load the motorhome in excess of the gross vehicle weight rating or the gross axle weight rating for either axle.

MAINTENANCE

- Do not remove the radiator cap while engine and radiator are still hot. Always check coolant level visually at the see-through coolant reservoir.
- Never get beneath a vehicle that is held up by a leveling system (if equipped), or a jack only.

- **Inspect the ladder** to make sure it is not damaged. Never use a damaged ladder.
- **Keep the rungs of the ladder clean and dry** while in use. Never use the ladder when it is raining, snowing, or icy. The rungs can become slippery. Do not step onto the rungs if the rungs are wet, or if your shoes are wet or carry mud or debris that could result in a loss of footing.
- **Never ignore warning labels** or weight limits defined on your ladder. The following warning label is located on or near the ladder:



SECTION 2 – SAFETY AND PRECAUTIONS



WARNING

Do not exceed 225-lb. maximum weight capacity. Misuse of ladder could result in death or serious injury. See Operator's Manual before using ladder.

- **Maximum Capacity: 225 lbs.**
- **Do not overload.** Ladder is intended for one person.
- **Make sure you are physically capable** to safely use the ladder. Strength, flexibility, and stability are required.
- **Be aware that the vehicle may sway** as you climb the ladder. Do not use the ladder in high winds.
- **As you climb the ladder,** grasp the side rails firmly and always use both hands. Keep your body centered between the side rails. Do not over-reach.
- **Never allow children** on the ladder.
- **Do not transport items** anchored to the ladder. You could damage the ladder.

FORMALDEHYDE INFORMATION

Some of the materials used in this recreational vehicle emit formaldehyde. Eye, nose, and throat irritation, headache, nausea, and a variety of asthma-like symptoms, including shortness of breath have been reported as a result of formaldehyde exposure. Reaction to formaldehyde exposure may vary among individuals. Elderly persons and young children, as well as anyone with a history of asthma, allergies, or lung problems may be at greater risk. Research is continuing on the possible long-term effects of exposure to formaldehyde. Inadequate ventilation may allow formaldehyde and other contaminants to accumulate in indoor air. Ventilation to dilute the indoor air may be obtained from a passive or mechanical ventilation system. Always be sure to thoroughly

ventilate your recreational vehicle before and during each use. High indoor temperatures and humidity may raise formaldehyde levels. When a recreational vehicle is in areas subject to high temperatures, an air conditioning system can be used to control indoor temperature levels. If you have any questions regarding the health effects of formaldehyde, consult your doctor or local health department.

MOLD, MOISTURE, AND YOUR MOTORHOME

What is Mold?

Molds are part of the natural environment. They are as old as the Earth itself and mold spores are almost everywhere at some level waiting to grow. Mold plays a part of nature by breaking down dead organic matter, such as fallen leaves and dead trees. Indoors however, mold growth should be avoided. Molds reproduce by means of tiny spores. Those spores are invisible to the naked eye and float throughout the outdoor and indoor air. Because of the nature of the use of a motorhome, it is natural for a motorhome to be introduced into an environment with mold spores.

Mold is a plant and requires its own special environment to grow. That environment includes organic materials, nutrients, moisture, and proper temperature.

How Can I Avoid Mold?

To reduce the ability for mold to grow, you must reduce what constitutes its growth environment. Mold can grow with the smallest of a nutrient base. Just small amounts of dirt or dust on the carpet can be enough to allow the mold process to begin. Keep the environment as clean as possible. Vacuum the carpet. Clean food spills thoroughly and quickly. Avoid grease buildup near the stove or sink. Clean the exhaust fan above the stove often.

Minimize moisture in your motorhome and keep humidity low. Clean spills quickly. Do not allow condensation to build up. You can open windows and vents to minimize condensation.



Use of the air conditioner can assist in removing moisture from the air. Avoid leaks, but if leaks do occur, make repairs promptly.

Avoid bringing mold into your motorhome. Plants, cloths, books, and other household items may already have mold present. It is easy to transfer mold into your motorhome environment.

Monitor your motorhome. Periodically check those hidden areas in corners, closets, and cabinets to assure mold is not present.

What if I Find Mold?

If mold develops, clean the area with a concentrate of soap and bleach. Items that contain mold that cannot be cleaned should be removed from the vehicle.

Can Mold Harm Me?

The effects of mold and airborne mold spores may cause irritation to some people. Experts disagree on the level of exposure that may cause health concerns.

If Mold Is Present, What Will Winnebago Industries® Do?

If Winnebago Industries determines that mold is present in the motorhome as a result of a manufacturing defect reported to Winnebago Industries within the limited warranty period, Winnebago will clean the affected area(s) and/or replace affected items as it deems necessary. This is the extent of coverage provided by Winnebago Industries. Winnebago Industries, however, will not assume responsibility for mold deemed to be a result of a motorhome users lack of timely and appropriate action to mitigate circumstances should a problem occur.

If Winnebago Industries determines that mold is present due to conditions it determines is not a result of a manufacturing defect found within the warranty period, Winnebago Industries will not provide any financial assistance to the repair of the condition.

ROADSIDE EMERGENCY

Because of the size and weight of this vehicle and its tires, and the possible complications involved in tire changing, we strongly advise obtaining professional road service to change a flat tire whenever possible. However, if an emergency requires you to change the tire yourself, please exercise extreme caution and read all tire changing information in the chassis manual.

Never get beneath a vehicle that is held up by a jack only.

If You Get A Flat Tire

- DO NOT panic.
- Grip the steering wheel firmly and steer the vehicle as straight as possible. Avoid quick maneuvers. You may need to counter-steer to compensate for “pull” created by the failed tire.
- DO NOT stomp on the brake. This abruptly shifts the vehicle’s weight forward, making it nose-dive and pull toward the blown-out side.
- DO NOT jerk your foot off the accelerator. Just ease back on the accelerator slowly and gently to continue momentum. The deflated tire will slow the vehicle.
- If you must change lanes to get to a safe stopping place, use your signals to warn other motorists and change lanes smoothly and carefully after you are certain the lane is clear.
- Let the vehicle coast to a stop, gently steering to a safe stopping place off the traffic lanes of the road. Do not worry about damaging the tire or wheel rim by driving on it. A tire or wheel replacement is cheaper than damaging the vehicle or injuring yourself.
- When you have come to a stop, activate your hazard flashers to warn other motorists, then exit the vehicle carefully.
- Set out flares or other warning devices.

Check your tires for proper inflation before each trip and at least once a month with an accurate tire gauge.



SECTION 2 – SAFETY AND PRECAUTIONS

Recovery Towing

When calling a professional towing service, we recommend that you advise them of your motorhome length and approximate front axle weight listed on your Vehicle Certification Label. This will allow the towing operator to determine the proper towing equipment to use.

Winnebago Industries® does not assume responsibility for damage incurred while towing this vehicle.

NOTE: Consult your chassis manual for towing instructions or precautions provided by the chassis manufacturer.

NOTICE

Do not lift on bumper. Damage will result to front end body parts.



WARNING

Stay out from beneath the motorhome while it is suspended by the towing assembly. Do not allow passengers to occupy a towed vehicle. Death or serious injury can result.

JUMP STARTING

If you wish to try jump starting the engine using another vehicle or booster system, see the chassis manual for connecting jumper cables to the automotive electrical system.

NOTICE

Do not attempt to push start this vehicle. Damage to the transmission or other parts of the vehicle will occur.

ENGINE OVERHEAT

If you see or hear steam escaping from the engine compartment or have any other reason to suspect an extreme engine overheating condition, pull the vehicle over to the roadside as soon as it is safe to do so, stop the engine, and get all passengers out of the vehicle.

NOTICE

Operating a vehicle under a severe overheating condition can result in damage to the vehicle.

For information on what to do in case of overheating, consult the chassis manual.

SECTION 3 – DRIVING YOUR MOTORHOME

The information in this section refers only to features installed or adapted to the dash and driver compartment area by Winnebago Industries®. It also includes passenger seating in the living area of the motorhome.

Further Information

See the chassis manual in your InfoCase for all original chassis related controls, instrumentation, switches, and other features. This includes items such as cruise control, climate controls, gauges, wipers, lights, front seats, and three-point safety belts, etc.

SEATS – DRIVER/CO-PILOT

The driver and co-pilot seats may be independently adjusted to suit individual preference.

The seats may be swiveled to provide easy entrance and exit. The swivel feature also allows the seats to be turned toward the living area for additional seating while the unit is parked.

The swivel seat alarm will sound when the passenger seat is rotated and the ignition is in the run position.



WARNING

Assure seat is in its forward and locked position for travel. Do not adjust seat while vehicle is in motion. Failure to comply may result in injuries.



Seat Recline

Front Height Control

Rear Height Control

Driver Seat
-Typical View

- **Seat Recline** - Lift up on the lever to operate.
- **Front and Rear Height Control** - Rotate the knob to adjust the seat up or down.
- **Lumbar Control** - Rotate the knob forward to increase and rearward to decrease the desired amount of lumbar support.



Swivel

Forward and Rearward
Adjusting Bar

Driver Seat
-Typical View

- **Swivel** - Lift up on the lever to operate.
- **Forward and Rearward Adjusting Bar** - Pull the bar upward to move the seat forward or rearward. Release at the desired position.

SECTION 3 – DRIVING YOUR MOTORHOME

Armrest Adjustment

The armrests may be swung upward out of the way for easy exit or access to the front seats. A roller on the underside of the front of the armrest also lets you adjust the resting angle for personal comfort, whether the seat is upright or reclined.



-Typical View

Further Information

See the chassis manual in your InfoCase for instructions on seat adjustments.

SEAT BELTS

Seats intended for occupancy while the vehicle is in motion are equipped with seat belts for the protection of the driver and passengers.

Lap Belts

The lap belts must be worn as low as possible and fit snugly across the hip area. Always sit erect and well back into the seat. To gain full protection of the safety belt, never let more than one person use the same safety belt at any one time, and do not let the safety belts become damaged by pinching them in the doors or in the seat mechanism. After any serious accident, any seat belts which were in use at the time must be inspected and replaced if necessary.

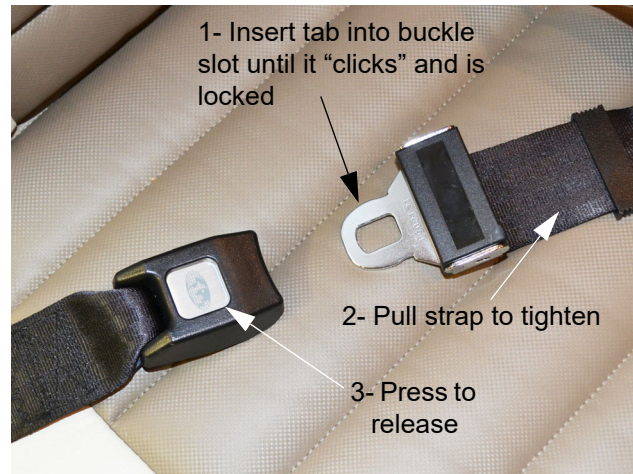

Adjustment:

To lengthen belt, swivel the tab end at a right angle to belt and pull strap to desired length. To shorten, pull loose end of belt.

To Fasten:

Be sure belt is not twisted. Grasp each part of the belt assembly and push tongue into buckle. Adjust to a snug fit by pulling the loose end away from the tongue.

To Release:

Press button in center of buckle and slide tongue out of buckle.



WARNING

Snug and low belt positions are essential. This will ensure that the force exerted by the lap belt in a collision is spread over the strong hip area and not across the abdomen, which could result in serious injury. Only seats equipped with seat belts are to be occupied while vehicle is in motion. Swivel seats must be in the locked, forward facing position while vehicle is in motion.

Lap/Shoulder Belts

Refer to the chassis manual provided in your InfoCase for instructions on proper fastening, adjustment, and releasing of lap/shoulder belts.

Seat Belt Care and Cleaning

- Be careful not to damage the belt webbing and hardware. Take care not to pinch them in the seat or doors.
- Inspect the belts and hardware periodically. Check for cuts, frays, and loose parts. Damaged parts should be replaced. Do not remove or modify the belt system.
- Keep belts clean and dry. If the belts need cleaning, use only a mild soap and water solution. Do not use hot water. Do not use abrasive cleaners, bleach, or dyes. These products may weaken the belts.
- Replace any belt assembly that was used during a severe impact. Replace the complete assembly even if damage is not apparent.

KEYS

Your motorhome is supplied with several keys. In addition to the chassis manufacturer's ignition key, you receive keys for the entrance door and exterior compartment doors.

Keys have an identification number, either a small metal tag or stamped into the key head. These numbers are recorded on the vehicle's component model/serial sheet, which is included in your InfoCase. In case keys are lost or stolen, your dealer or a locksmith can provide you with duplicate keys or modify the locks.

REMOTE KEYLESS ENTRY

The cab doors on your vehicle are featured with a chassis-supplied Remote Keyless Entry system, which you can lock and unlock these doors using the provided keyless remote transmitter.

Further Information

Refer to the chassis manual provided in your InfoCase for complete operating instructions on using the Remote Keyless Entry system and for battery replacement information.

HAZARD WARNING FLASHERS

The hazard warning flashers provide additional safety when the vehicle must be stopped on the side of the roadway and presents a possible hazard to other motorists. When the flashers are on, it serves as a warning to other drivers.

Further Information

Refer to the chassis manual provided in your InfoCase for instructions on activating, operating, and canceling hazard warning flashers.

AIR CONDITIONER/HEATER – AUTOMOTIVE (DASH)

See the chassis manual for operating information on driver and passenger comfort controls – air conditioner, heater, defroster, and ventilation.

NOTE: The dash air conditioner is not designed to cool the entire interior of the motorhome, but is intended only to provide cooling for the cab area.

WINDSHIELD BLINDS

–If Equipped

Your motorhome may feature a sliding pleated windshield blind. The blind stores at the dash and pulls up to cover the windshield for nighttime privacy and daytime room darkening purposes. The side tracks for the blind fold down when not in use and may include ignition alarm switches.

SECTION 3 – DRIVING YOUR MOTORHOME

NOTICE

If a track alarm is equipped, set the parking brake before raising tracks or the alarm will sound. Tracks must be stored before driving the vehicle.

To Extend the Windshield Blinds

1. Set the parking brake.
2. To remove the tracks, undo the velcro strap.



3. Lift each track and lock into place above the windshield.

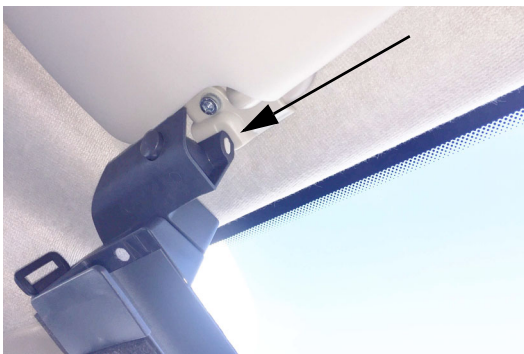

4. Lift the windshield pleated blind at the center handle to raise the shade into the fully extended position. If needed, adjust the rear view mirror to clear the shade.

Lift
Handle
to
Extend

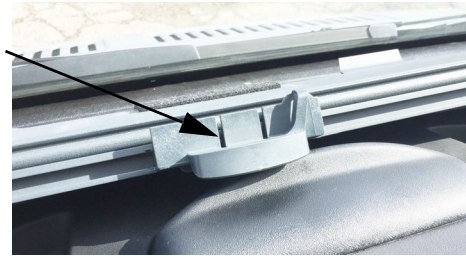

5. Lift the upper privacy screen.



To Retract the Windshield Blinds

1. Retract upper privacy screen.
2. Push the pleated blind downward into stored position.
3. Press the release button and lower the track into stored position.

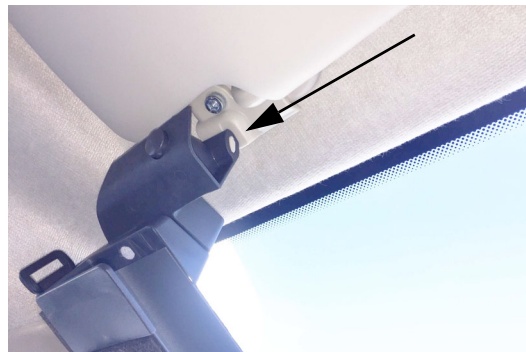

4. Secure the velcro strap.



5. Ensure the blinds are properly stored before driving the vehicle.

RADIO – IN-DASH

-If Equipped

The radio in your vehicle may be chassis-supplied. Refer to the chassis manual for complete features, programming, and operating instructions.

RADIO IN-DASH/REARVIEW MONITOR SYSTEM

-If Equipped

The radio in your motorhome can receive AM/FM stereo stations.

This system is also featured with a rearview camera monitor system, which lets you see what is directly behind your motorhome for safety and maneuvering assistance. The viewing screen is integrated into the dash.

The radio screen switches automatically when the transmission is shifted into reverse.



See the manufacturer's user guide provided in your InfoCase for complete operating instructions.

Bluetooth

-If Equipped

Your motorhome may be equipped with a Bluetooth microphone cable for hands-free cell phone usage.

See the manufacturer's information in your InfoCase for operating instructions.

Further Information

See the manufacturer's user guide provided in your InfoCase for complete operating instructions, including bluetooth and numerous other options.

ENGINE COOLING SYSTEM

Do not remove the radiator cap while engine and radiator are still hot. Always check coolant level visually at the see-through coolant reservoir.

NOTE: Your chassis engine cooling system is filled with special extended-life coolant. See the chassis manual for the correct type of coolant. The coolant system MUST be refilled or topped up with the same type of coolant as equipped to maintain the special long-life properties.

Further Information

Refer to the chassis manual in your InfoCase for information and precautions on filling, servicing, and checking the fluid level.

LIGHTS

All exterior lights should be checked for proper operation each time the vehicle is prepared for a trip. Any bulbs which fail to light should be checked and replaced, when necessary, with a new bulb of the same size. A failure of more than one light, such as both taillights not operating, may indicate a burned out fuse. Check fuse and replace with one of the same rating

SECTION 3 – DRIVING YOUR MOTORHOME

when necessary. If a fuse is not the cause of the problem, the wiring system should be checked immediately by an authorized service center.

Further Information

Refer to the chassis manual in your InfoCase for further information.

TIRES

Improper tire pressure can result in tire overloading and abnormal wear and also affects handling, ride characteristics, and fuel economy.



WARNING

Make sure all replacement tires are of the same size and rating as those shown on your Vehicle Certification Label.

SUSPENSION ALIGNMENT AND TIRE BALANCE

The front suspension and steering system of this vehicle was factory aligned using highly accurate equipment prior to delivery to the dealership. However, alignment should be checked and adjusted after you have fully loaded the motorhome according to your personal needs. Thereafter, the alignment should be periodically inspected to help prevent uneven tire wear.

Any excessive or abnormal tire wear may indicate worn or misaligned suspension or steering, unbalanced tire, or other tire/suspension problem.

Alignment can be affected by worn steering/suspension parts or by incidents which happen during driving, such as hitting a curb, pothole, or railroad track, etc. Improper alignment can cause tires to roll at an angle and wear unevenly. It may also cause the vehicle to “pull” to the right or left. Have your dealer inspect your vehicle’s suspension and steering components periodically for misalignment or wear.

Out-of-balance tires will not roll smoothly and can lead to vibrations and uneven tread wear, such as cupping and flat spots. Tires may need to be balanced if uneven wear is detected or if ride comfort decreases noticeably.

Further Information

Refer to the chassis manual provided in your InfoCase for further information.

HIGH PERFORMANCE WHEELS

-If Equipped

For the performance wheel option, when changing or installing the wheels you must make sure that the wheel is centered on the hub. You can do this by careful measurement, temporary spacers, or a centering ring. If the wheel is not centered in the hub you may experience a vibration similar to an out of balance tire. Winnebago utilizes centering rings that should remain on the vehicle when the wheels are removed. Whenever a wheel is removed be careful not to lose or break the centering ring. If you are placing the centering ring back on the tire, ensure that the wide edge is toward the hub side.



Tire centering ring.
-Typical view



Tire centering ring placed on
tire (wide edge toward the
hub side).

-Typical view



Tire centering ring is clearly
visible if it is installed.

-Typical view

NOTICE

If the wheel is not centered in the hub you
may experience a vibration similar to an
out of balance tire.

SECTION 4 – APPLIANCES AND SYSTEMS

The appliances installed in your motorhome are manufactured by reputable RV appliance makers and have been tested by independent laboratories to meet all applicable standards and codes set for RV appliances.

See *Section 2 - Safety and Precautions* of this manual for any safety and precautions you need to take regarding the operation of your appliances.

REFRIGERATOR

The refrigerator in your motorhome operates from 12-Volt DC Electric. The unit will always run on 12-Volt when 12-Volt is available. The refrigerator has 12-Volt power when the Pure³ button is ON.

The 12-Volt Converter will power the refrigerator when connected to 110-Volt power.



WARNING

Do not let children play inside the motorhome unattended. Unlike your home refrigerator/freezer that one could push open the door from the inside, your motorhome refrigerator has a travel latch and when engaged would trap a child inside resulting in suffocation leading to death or serious injury.

Basic Operation

- Turn the power on and set the thermostat between 3 and 4. Allow the refrigerator to cool down to temperature before placing food inside.

NOTE: The refrigerator will retain temperature more efficiently if food is cold before placing inside.

- To turn off the refrigerator, turn the thermostat counterclockwise past the click.

Further Information

Refer to the manufacturer's user guide provided in your InfoCase for complete operating instructions, safety precautions, and maintenance information.

RANGE TOP (ELECTRIC)

The range in your motorhome operates on electricity and will provide most of the functions of the range in your home.

Refer to the appliance manufacturer's user guide provided in your InfoCase for complete range features and operating instructions.



-Typical View

NOTE: See the appliance manufacturer's user guide provided in your InfoCase for complete operating instructions and safety precautions.

Avoiding Asphyxiation

The following warning label has been located in the cooking area to remind you to provide an adequate supply of fresh air for combustion.

Unlike homes, the amount of oxygen supply is limited due to the size of the recreational vehicle, and proper ventilation when using the cooking appliances avoids dangers of asphyxiation.

SECTION 4 – APPLIANCES AND SYSTEMS

It is especially important that cooking appliances not be used for comfort heating, as the danger of asphyxiation is greater when the appliance is used for long periods of time.

FAILURE TO COMPLY COULD RESULT IN DEATH OR SERIOUS INJURY.



WARNING

Portable fuel-burning equipment including wood and charcoal grills and stoves, shall not be used inside the recreational vehicle. The use of this equipment inside the recreational vehicle can cause fires or asphyxiation. Failure to comply could result in death or serious injury.

NOTICE

Turn off the range and allow it to cool before closing the range cover. The range cover is made of glass and may shatter when heated.

MICROWAVE OVEN

-If Equipped

Refer to the manufacturer's user guide located inside the appliance for complete operating instructions.

NOTICE

Do not store items in oven. If oven would turn on stored items can ignite resulting in fire and or property damage.

MICROWAVE/CONVECTION OVEN

-If Equipped

Refer to the manufacturer's user guide located inside the appliance for complete operating instructions.

NOTICE

Do not store items in oven. If oven would turn on stored items can ignite resulting in fire and or property damage.

ONEPLACE® SYSTEMS MONITOR PANEL

The OnePlace Systems Monitor Panel provides a convenient, central location for checking the condition of all utility systems in your motorhome.

At the touch of a button, the monitor panel will display the fresh water and holding tank levels, propane gas tank level, plus the chassis battery and house battery condition. You can also turn on the water pump.

Water And Holding Tank Levels

Press the Tank Levels switch to show approximate levels on the LCD screen.

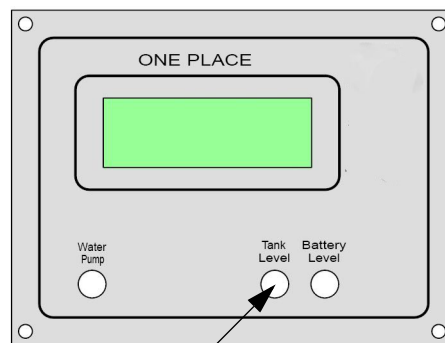

Tank Levels Switch

The approximate fluid levels are measured by electronic sensors on the sides of the tanks. Tank levels are displayed as 1/3, 2/3, and Full (F). There is generally more fluid in a tank than indicated on the monitor panel.

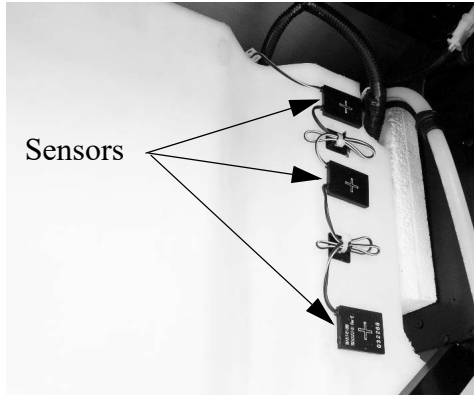

Water Tank
-Typical View

Tank Capacities

See “Tank Capacities” in *Section 1 - Introduction*.

Propane Gas Level

Press the Tank Levels switch to show approximate propane tank level.

The propane level is registered by a sending unit on the tank. The gauge mounted on the side of the tank will give a more accurate indication of actual tank level if needed.

Battery Charge Meter

Press the Battery Levels switch to check the level of charge (voltage) in the chassis and house battery.

This will read the chassis battery voltage. The house voltage is only showing the Pure³ Converter output voltage.

NOTE: The house battery will always read 14 volts.

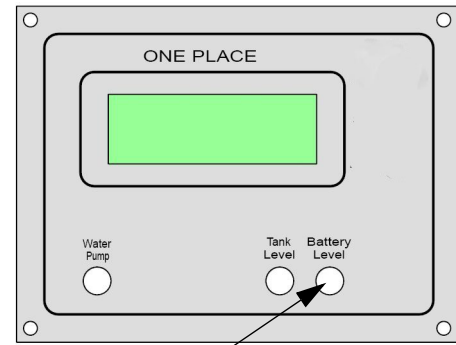

Chassis Battery Levels Switch

To get an accurate reading:

- The chassis engine must be shut off and 120-volt AC shoreline unplugged.
- An interior light should be turned on to provide a small load which draws off the battery surface charge.

Pure³ DC System (Volta)

See “Pure³ DC System (Volta)” in *Section 6 - Electrical* for further information.



Pure³ State of Charge (SOC) Gauge
(Located on an interior cabinet)
-Typical View

Water Pump Switch

Press the Pump switch to activate or deactivate. Water will be available as soon as a faucet is opened.

SECTION 4 – APPLIANCES AND SYSTEMS

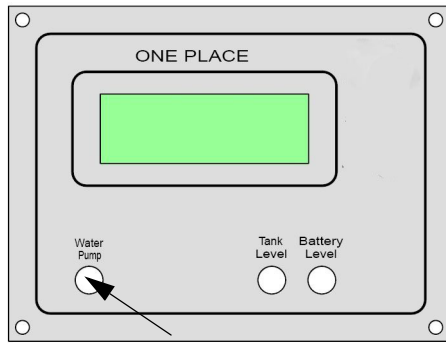

Water Pump Switch

Refer to *Section 7 - Plumbing* for additional information on the water pump and initial start-up.

Additional Water Pump Switch Location

When use of the self-contained water system is desired, turn the “Water Pump” switch on. Water will be available as soon as a faucet is opened. Refer to “Water Pump” for additional information on the water pump and initial start-up.

The switch has two locations, for convenience, one located on the Systems Monitor Panel, and the other on the Water Center Panel.

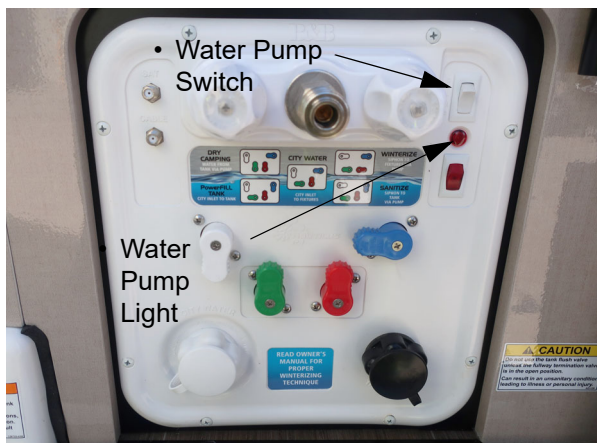

Water Pump switch located on Water Center Panel
-Typical View

NOTE: The indicator light will illuminate at the Water Center Panel when the water pump is on.

SOLAR CHARGE PANEL

The roof-mounted Solar Charge Panel uses the sun to help keep your house battery charged. A Solar Charge Controller (located inside an overhead cabinet) shows you when the Solar Charge Panel is actively charging the house battery. The Pure³ system needs to be activated for the solar system to charge.

The solar charging system installed in your motorhome has a maximum input rating of 500 Watts. Every solar panel connected to the system needs to be accounted for, this includes all roof mounted panels and the ground level single solar port.

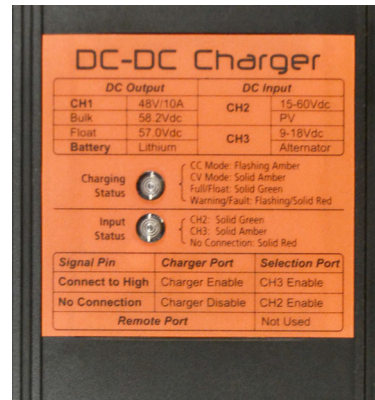

Solar Charge Controller
(Located inside an overhead cabinet)
-Typical View

Charging Status

Constant Current	Amber (Flashing)
Constant Voltage	Amber
Full/Float Mode	Green
Warning (High Temperature)	Red (Flashing)
Fault (Over Temperature)	Red

Input Status

Alternator Input	Amber
PhotoVoltaic Input	Green
Input Fault	Red

3-Port Solar Cap

The Port Solar Cap (located on the roof) is intended to make it easy to add additional solar panels to the roof. The 3 -Port Solar Cap when fully loaded has a maximum input rating of 450 Watts.



3-Port Solar Cap
(Located on the roof)

Single Solar Port

The Single Solar Port (located at ground level) is for using a portable solar panel, it has a maximum input rating of 150 Watts. The Single Solar Port is connected to the house battery through the solar charge controller (located on an exterior sidewall or inside an exterior compartment, depending on model). When

connecting a portable solar panel, a separate solar charge controller is not needed and will reduce the effectiveness of the portable solar panel.



Single Solar Port
(Located on an exterior sidewall)

NOTE: The Solar Charge Panel is not intended to make the house battery system “maintenance free.” The solar panel will not completely compensate for continuous low amperage draw from components such as the propane gas leak detector, for example. Although the Solar Charge Panel can help to extend battery life, the motorhome shoreline should be plugged in routinely to “top off” the battery. We also recommend following regular battery inspection and maintenance, especially in cold weather. See “Battery Care” in Section 6 - Electrical.

Further Information

Refer to the manufacturer’s user manual provided in your InfoCase for complete operating instructions.

**POWER CONTROL SYSTEM
(PCS)**

The Power Control System (PCS) monitors the electrical usage of the appliances and equipment in the motorhome and allows you to use certain high energy appliances, without overloading the shoreline/inverter circuit breaker or generator to help prevent nuisance tripping.

SECTION 4 – APPLIANCES AND SYSTEMS



PCS Display Panel
(Located near monitor panel)
-Typical View

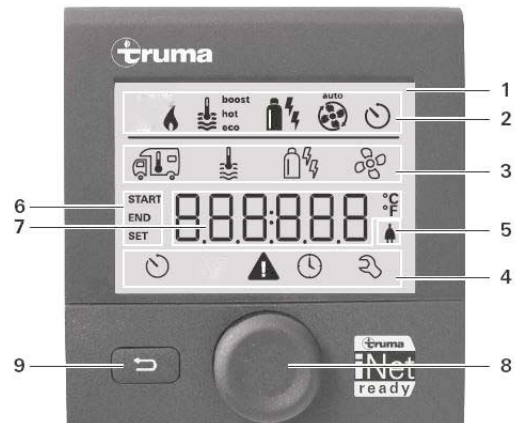

Control Panel
(Located near monitor panel)
-Typical View

Further Information

Refer to the manufacturer's user guide provided in your InfoCase for important information on how this system operates under several conditions, whether, 15-amp, 20-amp, 30-amp, or generator service.

HEATING SYSTEM – FURNACE AND INDIRECT WATER HEATING

The heating system in your motorhome is a propane and 110V power unit that provides warm forced air for heating and supplies hot water through an integrated boiler.

Read the Manufacturer's Operation Manual for complete Safety Warnings, Operating Instructions, and Maintenance Information before operating the heating system.

The control panel controls motorhome interior heating temperature, water temperature, and allows you to select energy sources for the system.

1. Display
2. Status Line
3. Menu Line (top)
4. Menu Line (bottom)
5. Power supply display 120VAC (mains supply)
6. Time Switch Display
7. Settings/Values
8. Rotary Push Button
9. Back Button

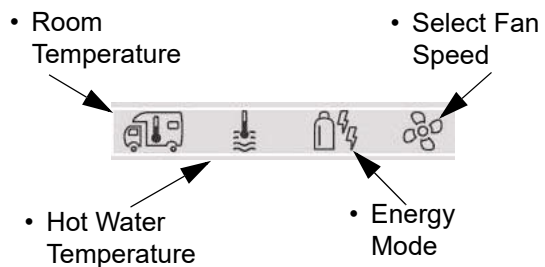

Menu Line (top)

ROTARY PUSH BUTTON: used to select menu items and to adjust settings.

- Turn clockwise or counterclockwise to scroll through the menu.
- Turn clockwise to increase values (+) and counterclockwise to decrease values (-).

- Tap to save a selected value.
- Press for three (3) seconds to turn the control panel on/off.

BACK BUTTON: used to go back to the previous menu or to cancel a setting.

Further Information

Refer to the manufacturer’s user guide provided in your InfoCase for complete operating instructions, safety precautions, troubleshooting, and maintenance information.

ROOF AIR CONDITIONING SYSTEM WITH BLUETOOTH CONTROL



Cooling Operation

- Press the selector button to the “Low Cool”, “High Cool”, or “Auto”.
- Set the temperature control to the position that is the most comfortable to you. When the temperature of the air entering the air conditioning unit rises a few degrees above the setting you have selected, the A/C will turn on. When the temperature of the air entering the air conditioning unit drops below the selected setting, the A/C will turn off. When the air conditioner is in the cooling mode, it will continue to cycle on and off until the selector button is turned to another operation mode.

- Position the louvers to the desired direction the discharge air is to flow.

During Cooler Nights

When outdoor temperatures drop in the evening or at night below 75 degrees F, the temperature control needs to be set at midpoint between “Warmer” and “Cooler”. If the setting is at “Cooler”, the evaporator coil may become iced up and stop cooling. During the day when temperatures have risen to at least 75 degrees F, reset the thermostat switch to the desired setting.

NOTE: Should icing up occur, it is necessary to let the evaporator coil defrost before normal cooling operation is resumed. At this time, operate the air conditioning unit in the “High Fan” position with the system at maximum airflow. When increased or full airflow is observed, the evaporator coil should be clear of ice.

Further Information

Refer to the air conditioner manufacturer’s information in your InfoCase for complete operating instructions, including Bluetooth operation. The app can be downloaded to your smart-phone via the appstore.

AIR CONDITIONER FILTER

The washable filters should be checked monthly for dirt build-up and cleaned or replaced as needed. It is located in the ceiling-mounted air conditioner grille in the lounge area.

Further Information

See the air conditioner manufacturer’s information in your InfoCase for removal and cleaning instructions.

SECTION 5 – PROPANE GAS

PROPANE GAS SUPPLY

The propane gas system supplies fuel for the gas range/oven and furnace. When used and handled properly, this system is safe and economical and provides modern living conveniences wherever you travel.

See Section 2 of this manual for other safety and precautions you need to be aware of related to propane.

How Propane Gas Works

Propane is a type of LP (Liquefied Petroleum) gas compressed into liquid form for easy transportation and storage. Propane gas may also be called tank gas, bottle gas, or simply LP.

Propane is used by appliances in vapor form only, but is stored in the tank as a liquid under very high pressure. As the liquid gas is released, it reverts back to a vapor and expands to many times its compressed volume.

Propane Tank System

The storage reservoir for the propane gas system is a horizontally mounted tank which is permanently attached to the vehicle frame. The tank is accessible only from the outside of the vehicle. The Propane Gas Tank is located under the center of the motorhome.



WARNING

Do not alter or remove propane tank valves or gauge. Propane can escape, which can cause an explosion resulting in death or serious injury. Have the propane system serviced by a qualified service center.

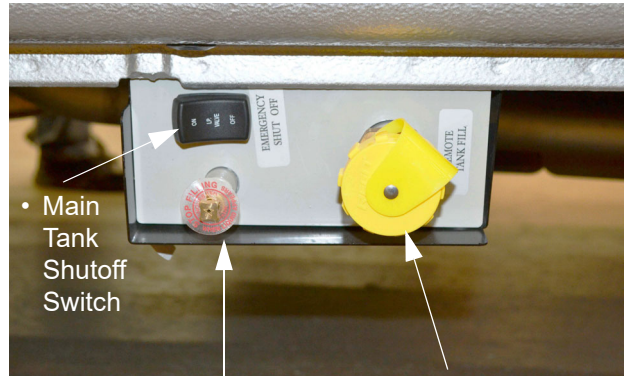

• Main Tank Shutoff Switch

• Overflow Valve

• Propane Tank Fill Valve

Propane Gas Access
(Located on driver side of motorhome)

Main Tank Valve Switch

The main tank valve is located out of normal reach, so a switch is provided on the front of the tank compartment and near the monitor panel when you need to open or close gas flow from the propane tank.



Main Tank Valve Switch
(Located near monitor panel area)
-Typical View

SECTION 5 – PROPANE GAS

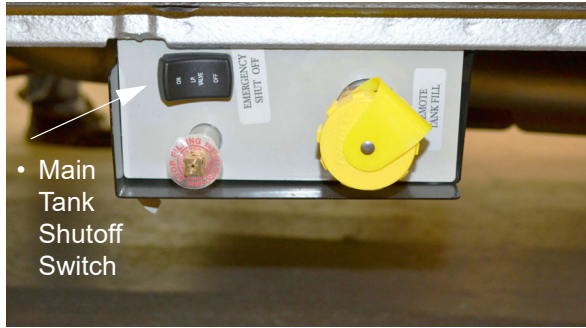

- Main Tank Shutoff Switch

Main Tank Shutoff Switch
(Located on driver side of motorhome)

NOTE: Both switches must be ON to allow propane supply to the motorhome. Propane gas flow will be stopped by turning either switch OFF. Turn the switch (inside the motorhome) OFF when propane gas supply is not needed to conserve house battery power.

Refilling Propane Tank

Since the propane tank is permanently mounted to the frame, the motorhome must be taken to a propane dealership for filling. Do not attempt to remove the propane tank from the vehicle. The tank is equipped with a fill adapter with both internal and external threads, which allows easy filling with any propane filling equipment. The tank is full when liquid propane gas appears at the overflow valve.

NOTE: The propane tank is equipped with an automatic 80% stop-fill device.



WARNING

Do not fill propane container(s) to more than 80 percent of capacity. A properly filled container contains approximately 80 percent of its volume as liquid propane. Overfilling propane container(s) can result in uncontrolled propane flow, which could lead to a fire or explosion and result in death or serious injury.



DANGER

All pilot lights, appliances, and their igniters (see operating instructions) shall be turned off before refueling of motor fuel tanks and/or propane containers. Can cause ignition of flammable vapors, which can lead to a fire or explosion and result in death or serious injury.



WARNING

This propane piping system is designed for use with propane only. Do not connect natural gas to this system. Securely cap inlet when not connected for use. After turning on propane, except after normal cylinder replacement, test propane piping and connections to appliances for leakage with soapy water or bubble solution. Do not use products that contain ammonia or chlorine to test for leaks. Can lead to a fire or explosion, which could result in death or serious injury.

Selecting Propane Fuel Types

We recommend using straight propane in your propane tank. Propane gas is commonly available at all propane gas outlets in the U.S. (According to the National Propane Gas Association, propane gas outlets in the United States do not offer any other type of liquefied petroleum gas than propane to the general public.) Check local phone directory yellow pages for locations of local propane gas refilling stations or bulk dealerships.

NOTE: If you travel outside the U.S. with your motorhome, you may find butane or propane/butane mixtures available in addition to propane. Because gas-burning RV appliances are designed to

run on propane only, we recommend that you request straight propane only. Butane burns about 30 percent hotter than propane and can overheat some appliances, particularly refrigerators, and cause permanent damage. Other appliances designed to operate on propane can become sooted and lose efficiency by using butane fuel.

Air in the Propane Gas Tank

If your gas appliances do not stay lit or require frequent adjustment, even though you know the propane tank contains sufficient fuel, the problem may be air in the propane gas tank. Air in the tank mixes with the propane gas vapors causing them to burn poorly. This condition could linger for weeks if the air is not purged from the tank. Most propane gas dealers have equipment for purging air from propane gas tanks and will purge before refilling the tank.

PROPANE ACCESSORY CONNECTION

Your motorhome is featured with a Propane Accessory Connection for your convenience, to connect items such as a portable BBQ grill.

This connection is on the low pressure side of the propane gas pressure regulator. Portable appliances which have an additional or built-in regulator may not operate correctly.

The Propane Accessory Connection is provided with a shut-off valve that has on/off indicator arrows. Rotate the shut-off valve “clockwise” to turn gas supply OFF. Rotate the shut-off valve “counter-clockwise” to turn gas supply ON.

See *Section 2 - Safety and Precautions* in this manual for other safety and precautions you need to be aware of related to propane.

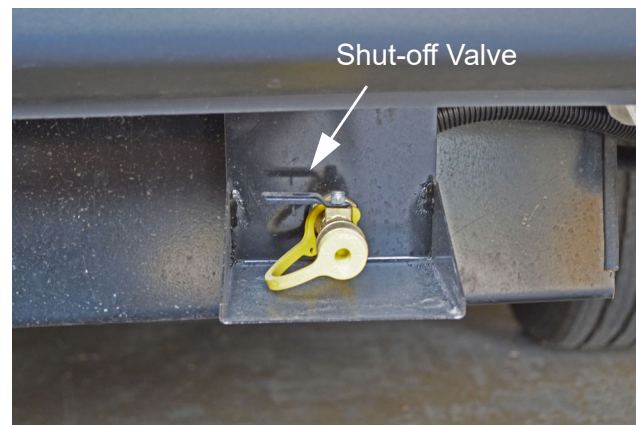
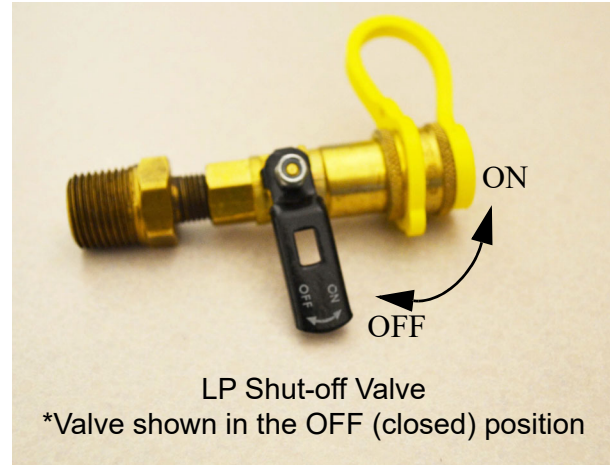

LP Accessory Connection
(Located at rear of motorhome)
-Typical View

 CAUTION
Turn valve off when not in use. Secure cap to outlet when not in use. After turning on gas, test gas piping connections to appliance for leakage with soapy water or bubble solution. Do not use products that contain ammonia or chlorine.

SECTION 5 – PROPANE GAS

SAFE USE OF THE PROPANE GAS SYSTEM

The propane system is designed and built with strict adherence to national, state, and recreational vehicle industry requirements for mobile propane gas equipment.

For your safety, there are many safety devices and backup systems installed, such as fill overflow valves, an interior propane gas detector/ alarm, and an interior carbon monoxide (CO) detector/ alarm.

Propane gas also contains an odor additive that you can smell if propane is present in the air.

Here are a few precautions to observe that will help you to use the propane gas system safely:

- Exercise caution at all times. Be familiar with the distinctive odor of propane gas. If a leak is suspected, turn off the supply valve immediately. Have the propane gas system checked by your dealer or other qualified propane gas service center.
- Do not tamper with the propane gas piping system, pressure regulator, or gas appliances. Service and maintenance of propane gas system components should be performed only by your dealer or a qualified propane gas service center.
- Never attempt to connect natural gas to the propane gas system.
- Have the entire propane gas system inspected for possible leaks and missing or damaged parts at each filling. Also inspect before and after each trip, and any time trouble is suspected.
- Turn the propane supply valve off when not using the propane gas system.
- Never use a wrench to tighten the supply valve. It is designed to close leak-tight by hand. If a wrench is required to completely close the valve, it is defective and must be replaced.
- Be sure appliance and outside vents are open and free from obstruction when using the propane gas system.

- Exercise caution when drilling holes or attaching objects to the walls. Gas lines and electrical wiring could be seriously damaged and present an extreme safety hazard.

PROPANE GAS WARNINGS AND PRECAUTIONS

It is illegal for vehicles equipped with propane container to travel on certain roadways or through certain tunnels in the U.S. To avoid inconvenience, check state regulations concerning flammable gas transportation.

Propane Gas Leaks

The following label is located in the vehicle near the range area. If you smell gas within the vehicle, quickly and carefully perform the procedures listed.

 **DANGER**

IF YOU SMELL PROPANE

1. Extinguish any open flames and all smoking materials.
2. Shut off the propane supply at the container valve(s) or propane supply connection.
3. Do not touch electrical switches.
4. Open doors and other ventilating openings.
5. Leave the area until odor clears.
6. Have the propane system checked and leakage source corrected before using again.

Ignition of flammable vapors could lead to a fire or explosion and result in death or serious injury.

- All pilot lights must be extinguished and appliances and their ignitors turned off while refilling the fuel tank or propane container.
- Never smoke while refilling vehicle fuel tank or propane gas container.

- Avoid inhaling exhaust gases produced by burned gasoline, diesel fuel, or propane gas in items such as the range, chassis engine, generator engine, furnace, and water heater. They contain carbon monoxide, which is an odorless, colorless, and poisonous gas.



WARNING

Do not place propane cylinders inside the vehicle.

Propane cylinders are equipped with safety devices that relieve excessive pressure by discharging propane to the atmosphere.

Propane gas is highly flammable.

Can lead to a fire or explosion and result in death or serious injury.

- Never use an open flame to test for propane gas leaks. Replace all protective covers and caps on propane system after filling. Make sure valve is closed.
- Portable fuel-burning equipment, including wood and charcoal grills and stoves, shall not be used inside the recreational vehicle. The use of this equipment inside the recreational vehicle may cause fires or asphyxiation.
- Regulators are equipped with a protective cover. Make sure that the regulator vent faces downward and that the cover is kept in place to minimize vent blockage, which could result in excessive gas pressure causing fire or explosion.

PROPANE GAS PRESSURE REGULATOR

The pressure regulator is protected from the elements by a plastic cover, which should be left in place at all times.

Propane regulators must always be installed with the regulator vents facing downward. Regulators that are not in compartments have been equipped with a protective cover. Make sure that the regulator vent faces downward and that

the cover is kept in place to minimize vent blockage that could result in excessive propane pressure causing fire or explosion.

Only your dealer or a qualified propane gas service should remove the regulator cover for adjustments.



WARNING

Visually inspect the pressure regulator vent periodically for blockage by accumulated debris or insect nests, etc. Vent obstruction could result in excessive pressure causing fire or explosion, which could result in death or serious injury. If an obstruction exists, have the regulator serviced by a qualified service center.

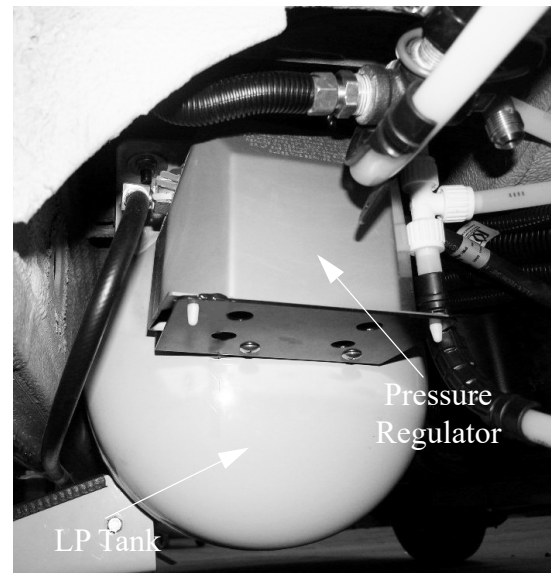

-Typical installation shown

SECTION 5 – PROPANE GAS

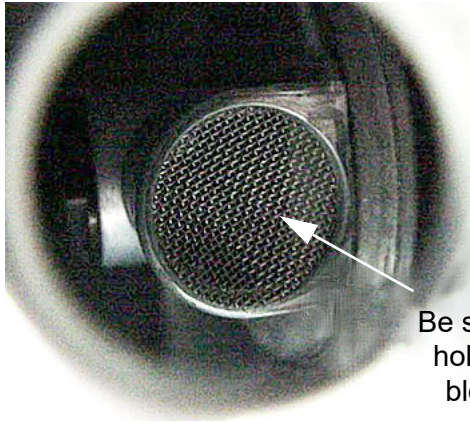

Be sure vent
hole is not
blocked.

Regulator Freeze-up

Regulator freeze-ups are caused by the presence of moisture in fuel. This moisture will pass through the cylinder valve and into the regulator where it can freeze. Fuel producers, tank and bottle manufacturers, and propane gas dealers take every precaution to reduce moisture, but sometimes only a fraction of an ounce entering the tank can cause problems. To help avoid the possibility of freeze-up, always keep tank control valve closed when not in use, even when tank is empty, to prevent moisture from collecting on the inside.

If regulator freeze-up should occur, you may attempt to thaw the regulator using a light bulb. **DO NOT USE AN OPEN FLAME OR HEAT LAMP.**

If moisture begins to cause problems, have your propane gas dealer inject a small amount of dry methyl alcohol in your tank (approximately one ounce to 20 pounds or one pint to 100 gallons) to help guard against regulator freeze-ups.

PROPANE VAPORIZATION IN COLD WEATHER

Propane gas vaporization increases and decreases in direct relation to ambient temperature. In other words, the lower the temperature, the slower the liquid propane will vaporize into a usable gas for appliances.

This means that in extremely cold weather when a large volume of gas is being used by the furnace for heating, it is possible to experience a loss of gas pressure.

At first, this problem may appear to be caused by an empty tank or a regulator freeze-up, but is actually caused by failure of the liquid gas to vaporize as fast as it is needed by the furnace.

The demand for propane to produce heat increases to the point where the gas cannot vaporize fast enough to keep the furnace going. The only solution to this problem is to reduce gas usage where possible.

Adjusting the temperature on the gas/electric refrigerator may be a first step. Using less hot water will also help, as well as refraining from using the gas cooktop. A final step is to lower the thermostat setting to reduce gas usage by the furnace.

SECTION 6 – ELECTRICAL

Your motorhome is equipped with an electrical system consisting of three separate voltages:

- 12-volt DC
- 48-volt Pure³ DC
- 120-volt AC (household current)

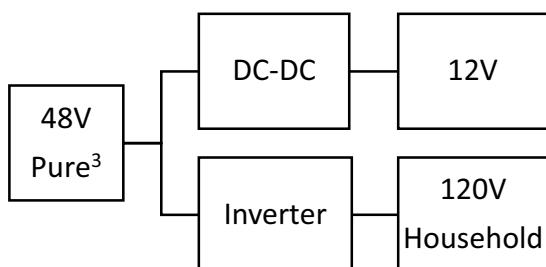

ELECTRICAL CAUTIONS

- Careless handling of electrical components can be fatal. Never touch or use electrical components or appliances while feet are bare, while hands are wet, or while standing in water or on wet ground.
- Improper grounding of the vehicle can cause personal injury. Do not plug the utility power cord into an outlet which is not grounded and do not adapt the plug to connect to a receptacle for which it is not designed.
- Do not attach an extension cord to the utility power cord.
- Be sure that all electrical appliances to be used contain 3-prong plugs for proper grounding.
- Avoid overloading electrical circuits. Replace fuses or circuit breakers with those of the same size and amperage rating only. Never use a higher rated fuse or breaker.
- Use caution when handling or working near electrical storage batteries. Always remove jewelry and wear protective clothing and eye covering. Avoid creating sparks.
- Do not drive through flooded areas or deep water.

- Do not incinerate a Volta energy storage pack system.
- Operate a Volta energy storage pack only within the recommended limits for temperature, voltage, current, SOC, and other environmental conditions.

ELECTRICAL SYSTEM – HOUSE 120-VOLT AC

The 120-volt system operates from the shoreline cord connected to an outside 120-volt utility service, such as those at campgrounds or from the Pure³ power source. When the shoreline cord is connected to an outside power source, or when the Pure³ power source is running, the power converter automatically changes a portion of the Pure³ current to 12-volt DC current.

In addition, the following equipment is entirely dependent on 120-volt current: air conditioner, microwave oven, and any 120-volt electrical equipment used at convenience outlets.

POWER CORD – EXTERNAL (DETACHABLE) (Shoreline)

The external power cord (commonly referred to as a “shoreline”) is located beneath the rear bed in the left side storage cabinet (Model 59GL) or underneath the wardrobe (Model 59KL).



WARNING

Do not use an extension cord. Improper sized cords, damaged cords, and poor connections can lead to fire, which can result in death or serious injury.

SECTION 6 – ELECTRICAL



WARNING

Do not connect the external power cord to any receptacle until you have verified proper polarity and grounding. Be sure all prongs of the supply cord are properly plugged into the receptacle. Failure to observe can result in death or serious injury.

To connect to an external power source, plug the adapter end into the sidewall plug-in (located on driver side sidewall) and the receptacle end to a suitable power outlet box.

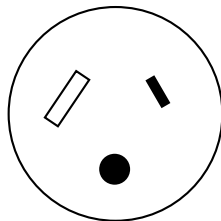

30 Amp Receptacle



WARNING

This connection is for 110/125 Volt AC, 60 Hz 30 Ampere supply. Do not exceed circuit rating. Exceeding the circuit rating may cause a fire and result in death or serious injury.

The power cord is designed to ground the electrical system through the receptacle. It is also designed to carry the amperage output of most campground outlets. If the electrical receptacle to be used is designed to mate with the prongs of the power cord plug, the electrical connection can be expected to carry rated load.

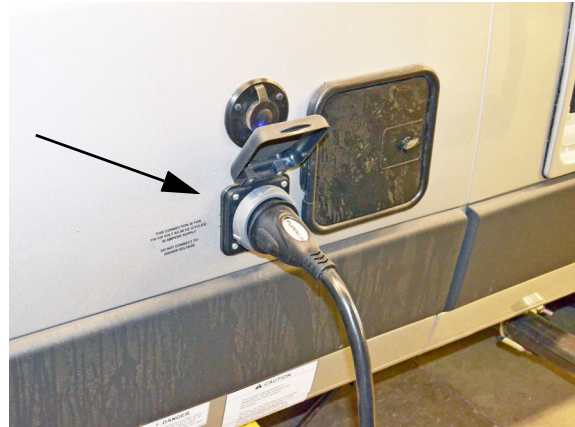

Detachable Power Cord
-Typical View
*Model 59GL shown



WARNING

Service inlet access must be closed when utility connections are not in use.

Park Fuses or Breakers

Most campgrounds are equipped with a fuse or circuit breaker at the receptacle (which we recommend shutting off before engaging or disengaging the power cord.) This protects the park's wiring, as well as the power cord on your vehicle from electrical damage. If electrical power fails, contact the park attendants and have them check the fuse or breaker for your supply receptacle.

INVERTER/CHARGER UNIT – 3600W

The inverter changes Pure³ DC power into 120-volt AC power for use by 120-volt AC equipment inside the motorhome. The charger changes 120-volt AC power from shoreline to Pure³ DC power. The inverter/charger unit is located inside an interior cabinet.

NOTE: Running the Inverter causes a parasitic draw on the Pure³ battery. It is recommended to turn the inverter off when not in use for maximum battery run

time. Monitor Pure³ levels regularly when not connected to shoreline power. The inverter can also be used while driving the motorhome because the engine alternator will charge the battery while driving.

The inverter has built in GFCI protection. The GFCI will protect against electrical shock by interrupting the flow of electricity. If there is no power from the inverter the GFCI may have tripped. Reset the GFCI by pressing the RESET button. If the GFCI continues to trip, have the electrical system checked and repaired, if necessary, before using the inverter again.

GFCI Reset Button

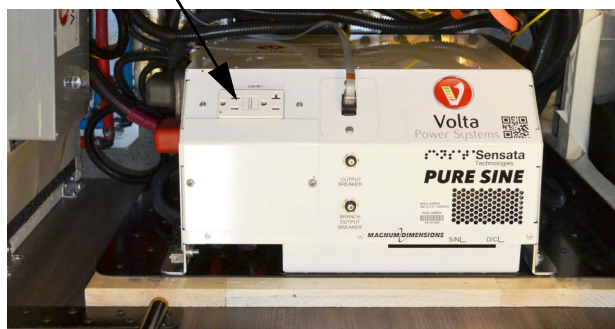

Inverter Unit

- Model 59GL: Located beneath the side facing dinette seat.
- Model 59KL: Located beneath the right bed cabinet.

-Typical View

NOTICE

Do not store items around the inverter unit. The inverter generates heat while operating and needs unrestricted airflow for proper cooling. Damage to the inverter can result.

Inverter Control Panel

The inverter has a wall-mounted monitor/control panel. It will also indicate warnings for overload conditions or other operating failure conditions.



Inverter Control Panel
(Located near monitor panel)
-Typical View

See “Pure³ DC System (Volta)” in this section for further operating instructions.

When the inverter is not being used, it should be shut off at the control panel. The inverter could drain the Pure³ power source if the shoreline is not connected to external power.

Further Information

Refer to the manufacturer’s user guide provided in your InfoCase for complete operating instructions and charging setup directions.

POWER CENTER

(Converter)

The power converter is located near the wardrobe (Model 59GL) and on the right side twin bed cabinet (Model 59KL).

The power converter changes the Pure³ DC source into 12-volt DC current for use by 12-volt equipment in the motorhome.

NOTE: The converter will not change 12-volt DC current to 120-volt AC.

SECTION 6 – ELECTRICAL

NOTICE

Do not block the converter cover vents in any way. The converter generates heat while operating and needs unrestricted airflow for proper cooling. Damage to the converter can result.

Further Information

See the manufacturer’s operation, care and maintenance information in your InfoCase.

Charging Section

The inverter/charger charges Pure³ DC battery while 120-volt external power is connected. The inverter/charger will automatically “sense” the condition of the battery. A secondary engine alternator will charge the Pure³ DC battery while the vehicle is running. If it is below “full charge”, the Charging Section will start charging the battery.

If the Pure³ DC battery has been extremely discharged, it will accept charge at a relatively high amperage rate. If it is only slightly discharged, it will charge at a lower amperage rate. The rate of charge will decrease as the battery reaches “full charge”. If your battery does not charge as described above, it is possible the battery is defective.

Protection Modes

Over Temperature: In the event of an over temperature condition the power converter will be inhibited until it has cooled off and then restarts automatically. This is indicated by the Status LED blinking red at a five second interval. In very high ambient temperatures or poor ventilation, it is possible for the non-automatic reset thermal protection to activate. If this occurs, the DC power should be disconnected and reconnected once the power converter has cooled off.

Over Voltage: Over voltage protection activates in the event of a regulation malfunction. The power converter is inhibited until DC power is recycled. This condition is indicated by the Status LED flashing red. If over voltage protection activation events persist, the factory should be consulted.

Over Current: Activates in the event of a current regulation or current limit malfunction and inhibits the power converter until the over current condition is removed. If over current protection activation events persist, the factory should be consulted.

CIRCUIT BREAKERS – HOUSE 120-VOLT AC

The breaker panel protects all 120-volt components in the motorhome from either an overload on the circuit or a short in the wiring or component itself. When an overload or short develops, the breaker will open preventing damage to the system.

Shut off the equipment (example: roof air conditioner) and allow a brief cooling period. Then reset the breaker by moving the switch to “Off” and back to “On”. If the breaker is continually tripped and no overload is evident, have the system checked for a short in the wiring or the appliances.



120-Volt Circuit Breakers
-Typical View

NOTE: Typical view of breaker panel. Breaker arrangement may vary according to appliance and equipment options. Fuses and breakers are labeled on panel.

ELECTRICAL OUTLETS – HOUSE 120-VOLT AC

A number of standard household electrical outlets are provided throughout the motorhome for connecting small appliances such as televisions, radios, toasters, etc.

An exterior outlet is also located in the rear storage compartment on the passenger side of the motorhome.

GROUND FAULT CIRCUIT INTERRUPTER

Bath, galley, and exterior outlets are connected to a GFCI (Ground Fault Circuit Interrupter), which is an extremely sensitive circuit breaker that will help to protect against severe electrical shock if a ground fault develops. If such a condition occurs, the GFCI will break the circuit by turning off the power to the protected outlets. Should this occur, unplug all the appliances on that circuit and press the reset button on the GFCI equipped outlet.

If the GFCI keeps tripping, have the electrical system checked and repaired, if necessary, before using again.

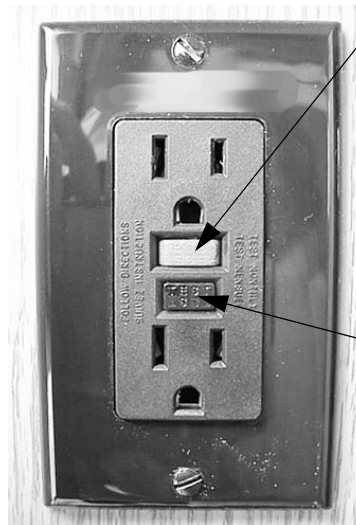

- Push to Reset circuit after monthly testing or ground fault tripping.

- Push to Test at least monthly. Should break circuit. Press Reset button to reconnect.

GFCI Outlet
(Ground Fault Protector)



WARNING

The GFCI will not completely eliminate the risk of electrical shock. Infants and small children may still be affected.

ELECTRICAL SYSTEM – HOUSE DC

The House DC voltage system consists of the Pure³ DC system and the 12-volt power converter.

Converter

See “Converter” previously in this section.

Chassis Battery

The chassis battery is used to operate the engine starter and automotive accessories and controls found on the instrument panel. The electric step is also connected to the chassis battery.

Refer to your chassis manual provided in your InfoCase for further information on chassis battery and chassis electrical system.

SECTION 6 – ELECTRICAL

BATTERY ACCESS

NOTICE

Always refasten battery retainers when returning a battery to the compartment.

Chassis Battery

The chassis (starting) battery is located beneath the driver side floor mat.



Chassis Battery Access
(Located beneath driver side floor mat)
-Typical View

Further Information

See the chassis manual provided in your InfoCase for details on access and servicing.

CHASSIS BATTERY CARE

Lead-acid type batteries are electro-chemical devices for storing and releasing electrical charge. As such, they are simply an electrical reservoir, not an electrical source. As soon as energy is removed from the battery, it should be replaced by the engine alternator or the motorhome converter system.

If a battery sits unused for 30 days or more, especially during warm weather, it can develop a deposit of sulfate crystals on the metal plates

inside the battery. This condition is called “sulfating” and prevents the battery from either releasing or accepting a charge. If this condition occurs, the battery must be replaced.

If a battery does not contain at least 80% charge during freezing temperatures, the electrolyte can freeze and crack the battery case.

NOTICE

Disconnect battery before connecting external charging equipment to avoid damage to sensitive electronic components.



WARNING

This vehicle, like other vehicles, may contain small amounts of one or more substances which are listed by the state of California for causing cancer or reproductive toxicity.



WARNING

California Proposition 65 Warning: Battery posts, terminals, and related accessories contain lead and lead compounds, chemicals known to the state of California to cause cancer and reproductive harm. Wash hands after handling.

NOTE: Do not leave the shoreline plugged in during storage. Follow regular battery inspection and maintenance.

Further precautions are:

- Check the state of charge periodically to avoid discharge or sulfating.

To ensure that the battery will always accept and hold a charge, follow these simple maintenance practices:

- Make sure the battery always remain securely clamped in the battery tray.
- Make sure battery cable clamps are tight on the terminal posts and are free of corrosion.
- Neutralize corrosion buildup or acid film on top of battery by washing with a baking soda/water solution. Rinse with clear water.

NOTE: Make sure vent caps are on securely to prevent baking soda solution from entering the battery and contaminating the electrolyte fluid.



WARNING

Before removing any battery cables or battery, make sure all 12-volt equipment in the motorhome is off and the power cord has been disconnected. Be sure to replace the battery terminal boot, if supplied, back onto the positive terminal after servicing. Care must be taken to avoid pinching the cable between any metal parts. Should the cable be damaged, a short circuit could result in personal injury or damage to equipment. Replace any damaged cables at once. Always remove jewelry and wear protective clothing and eye covering when checking or handling batteries.

- Clean and tighten battery terminals and have the specific gravity checked at least once a year.



WARNING

To prevent wiring damage, it is essential when replacing the cables on the battery, or when using a “booster” battery, that the positive post and the positive cable be attached and the negative post and negative cable be attached. The posts are marked (+) plus and (-) minus. If a “boost charger” is used while battery is in the motorhome, disconnect both battery cables before connecting the charger to avoid damage to engine electronic components. Never attempt to charge or boost a frozen battery. An explosion can occur resulting in personal injury.

Chassis Battery

If your motorhome is going to be unoccupied for two weeks or more, Winnebago Industries® recommends disconnecting the chassis battery in your motorhome to avoid battery discharge.

CIRCUIT BREAKERS AND FUSES

All 12-volt circuits and equipment in the motorhome area of the motorhome are protected by either a fuse panel or breaker panel. When a circuit is overloaded or a short develops in any part of the system, a fuse or breaker will shut down that circuit. If this happens, turn off all affected lights or appliances and reset the breaker or replace the fuse with a new one of equal amperage rating.

House 12-Volt Fuses

A label on the panel states the amperage rating and circuit protected for each fuse.

SECTION 6 – ELECTRICAL



House 12-Volt Fuses
(Located on right side twin bed
cabinet at rear)
-Typical View

The fuse panel accepts only blade type plug-in fuses. Always replace fuses with those of the same amperage rating.

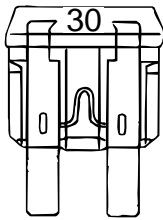

Functional

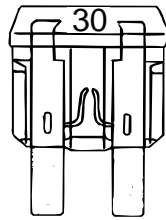

Non-Functional

Battery Charge Meter

See related item under “Systems Monitor Panel” in *Section 4 - Appliances*.

Trailer Plug Fuses

The trailer plug fuses are located behind the plastic panel on the pillar behind the passenger seat.



Trailer Plug Fuses
(Located behind plastic panel on pillar behind
passenger seat)

- 10 Amp Fuse - Ignition (wires MK, SJ)
- 10 Amp Fuse - Trailer Plug (wires MK, TD)

-Typical View

PURE³ DC SYSTEM (VOLTA)

! WARNING

Only Volta approved technicians should service the Pure³ energy storage and power distribution system. For safety reasons end users and other untrained individuals should not attempt to open or tamper with the battery pack or any other components of the Pure³ energy storage and power distribution system.

Pure³ energy storage packs are designed for connection and operation with Volta Power Systems power distribution devices or equipment expressly approved by Volta Power Systems. This ecosystem of approved devices is a layer of safety within the Pure³ system and use of other devices compromises this layer of safety. Use of the Pure³ energy storage pack with other external devices could present a hazard and is expressly prohibited by Volta Power Systems as well as voiding the Volta Power Systems warranty.

! WARNING

Auto Engine Starting installed. Carbon-monoxide (CO), moving parts, and Shock can cause severe injury or death.

Turn off Volta Pure³ system to store or garage RV and before servicing RV electrical systems.

! CAUTION

The Pure³ Power System components are designed to work safely together as a system. Components and devices in the Pure³ Power System should not be opened or modified. Only a Volta approved technician should perform service work on a Pure³ system.

Activate System (Discharging)

NOTE: The Volta gauge/button is equipped with a magnetic cover to dim the lights at night.

1. Press and Release the Pure³ ON/OFF button. Wait for approximately 5-10 seconds and the button will illuminate green.



Pure³ ON/OFF Button
(Located on an interior cabinet)
-Typical View

2. The State of Charge (SOC) gauge will also illuminate and show the current state of charge of the Pure³ battery pack.

SECTION 6 – ELECTRICAL



Pure³ State of Charge (SOC) Gauge
(Located on an interior cabinet)
-Typical View

3. The system is active and ready for use.
4. When the system is activated the inverter default will be on.

De-Activate System

Press and Release the Pure³ ON/OFF button. When you turn the system off, the green light on the ON/OFF button may stay on for a period of time while the system shuts down all components. This can last up to a couple minutes. The SOC gauge will also blink blue during this time. You will know the pack is properly shut down when the lights on the button and gauge are completely off.

Charging

Pure³ energy storage packs are designed to safely charge utilizing Volta approved power distribution devices. Charging devices include the Pure³ alternator, Pure³ solar charger, and Pure³ inverter/charger. No additional charging devices should be connected to a Pure³ system. Doing so could cause a potentially unsafe condition that could damage or destroy your system.

Charging from Shoreline

When plugged into shore power, the Pure³ system will begin charging.

NOTICE

If the system does not transfer power and begin charging, the cause is likely due to poor quality incoming power. This feature protects the vehicle from brown outs due to insufficient power, a common occurrence when large numbers of vehicles are tied to one shore power source. If the Volta energy storage pack still has remaining energy, the vehicle systems should remain operational.

Adjustable Charge Rate

When the system is turned on for the first time, the charger current limit defaults to 15 Amps. After that the system remembers the last setting.

Refer to the LCD Display Supplement manual provided in your InfoCase or use the following instructions for directions on how to change the charger current limit.

Instructions to change the Battery Charger Current Limit

1. Press and Hold Inverter Display panel “DISPLAY” button for 5 seconds.
2. Press the “NEXT” button until display reads “Max Branch Amps”.
3. Press the “ENTER” button and an “S” will appear in the lower right corner of the display indicating that you can change the setting.
4. Pressing the “NEXT” button will cycle through the available values.
5. Once “30 Amps” is displayed, select the “ENTER” BUTTON.
6. The “READ DISPLAY” LED will blink twice to confirm that the setting was changed.
7. Press the “ESC” button until back to the “RUN” mode display.

You may encounter the following messages on the Inverter Control Panel. They are not error messages.

CHG#1-OFF DISABLED BY JMPR	The battery is full. The battery is too cold to charge.
CHG#1-AC IN LIMIT	Informational only, not an error.

NOTICE

The inverter/charger is capable of adjustable charge rate, with a default charge rate of 15 Amps. If during charging the shore power breakers trip, the charge rate can be reduced in 5 amp increments on the inverter/charger display until a charge rate has been reached that does not trip the shore power breaker.

Charging and Operation while Driving

Your vehicle will charge automatically while you drive. Charging occurs when the engine speed is between 1500 and 3700 RPM's.

NOTE: The alternator may not always be ON while the vehicle is running. If the battery pack is above a set State of Charge (SOC) the alternator will be OFF until the pack controller determines it is appropriate to turn on the alternator.

Charging with Auto-Start Feature

NOTICE

The system will not activate without the hand brake engaged.



CAUTION

Check with State and Local regulations on vehicle idling before activating the Auto-Start feature of the Pure³ Power System.

Initiating Auto Start - Key Fob Method

1. Set the hand brake.
2. Using Key Fob - push middle lock button three times. The headlights will flash and the horn will sound.



3. Dashboard will remain lit for 10 to 30 seconds. The silver button next to the steering column will illuminate red indicating auto start is activated.



4. When the state of charge reaches approximately 10%, the vehicle will start and run in high idle.

SECTION 6 – ELECTRICAL

Disabling Auto Start - Key Fob Method

1. Using the Key Fob - press the top unlock button three times.



2. The silver button next to the steering column will darken indicating auto start is deactivated.

Activating Auto Start - Stealth Method

1. Set the hand brake.
2. Insert key into ignition and turn towards crank position. Do not start the vehicle.



3. Leaving the key in crank position, push and hold the silver button on the left-side of the steering column for 2 seconds. Remove the key from the ignition. The horn will not sound.
4. Dashboard will remain lit for 10 to 30 seconds. The silver button next to the steering column will illuminate red indicating auto start is activated.



Disabling Auto Start - Stealth Method

1. Insert key and turn towards run position.
2. Press and hold silver button for 2 seconds.
3. The silver button next to the steering column will darken indicating auto start is deactivated.

Manual Recharge (On-Demand)

1. Engage the Auto Start using the key fob or stealth mode method.
2. Press the silver button next to the steering column three times. The vehicle will start and go into high idle.

Disable Manual Recharge

1. Press the silver button next to the steering column three times. The vehicle will shut down.
2. The silver button next to the steering column will darken indicating auto start is deactivated.

Manually initiated high idle or auto start will run until one of the following parameters are met:

- Engine has been running for 60 minutes.
- Engine coolant temperature reaches 223°F.
- Pure³ battery charge reaches approximately 90%.
- Chassis fuel level is down 25%.

Initiating Manual Charge Cycle with Doors Locked

1. Arm the auto start using the Key Fob or Key/ Button Method.
2. Open driver side cab door and step out.
3. Press the illuminated red button three times to start the manual charge cycle then promptly and firmly press the lock button on the key fob three times.

NOTE: This must be done before the engine's RPMs increase and may be difficult with a cold engine.

Opening the Chassis Hood

The auto start system will not initially go into monitor mode if the hood is unlatched. The hood can be unlatched once the auto start is in monitor mode, but the engine will not start while the hood is unlatched.

If the engine starts while the auto start is in monitor mode and the hood is latched, you may unlatch the hood. Once the engine shuts down the hood must be latched before the engine will restart.

High Idle and Anti-theft:

- Brake must be depressed to put the motorhome into gear.
- Depressing the brake causes the engine to shut off for a five-minute period, preventing a drive-away.
- Auto start **must** be disabled before driving away.

Operating Parameters

Voltages

Maximum Pack Voltage	100%	58.52V
Normal Pack Voltage	50%	51.53V
Pack Shutdown Voltage	10%	48.61V*
Auto-Start Initiate Voltage	25% – 35%	49.98V*
Auto-Start Terminate Voltage	90%	57.01V*
* Values may differ +/- 0.3V		

Temperatures

The battery pack is in a sealed and insulated compartment. When the temperatures in the compartment are getting too warm for the pack to operate on environmental, the fan will use the interior of the motorhome to cool the pack. When the temperatures of the pack are too cool for the pack to operate, a heating pad will warm the pack.

Battery Compartment Environmental Fan

- Fan will turn on at 43°C/110°F (Cool Mode).
- Fan will turn off at 32°C/90°F (Cool Mode).

Battery Pack Heating Pads

Please note that your Pure3 battery pack is a large mass to warm up and may require several hours to bring the pack up to 43°F for charging to resume. Ambient temperature and other environmental variables will affect the time required.

- The vehicle must be plugged into shore power or the inverter must be turned on for the heating pads to operate.
- Heating pads will turn on at 5°C/41°F (Heat Mode)

SECTION 6 – ELECTRICAL

- Heating pads will turn off at 8°C/46°F (Heat Mode)

Discharging

- High Temperature Limit: 57°C/135°F
- Low Temperature Limit: -20°C/-4°F.
- If High Temperature Limit is reached, the pack must cool to 52°C/126°F before discharge can continue.

Charging

- High Temperature Limit: 47°C/117°F.
- Low Temperature Limit: 3°C/37°F.
- If High Temperature Limit is reached, the pack must cool to 43°C/109°F before charging will resume.
- If Low Temperature Limit is reached, the pack must heat to 6°C/43°F before charging will resume.
- The SOC gauge will turn blue in 5 second intervals when the storage pack is too cold to charge.
- The SOC gauge will turn yellow in 5 second intervals when the storage pack is too hot to charge.

Storage

As with any storage system, like batteries, fuel or water tank, preparations should be made to protect the life and performance of the Pure³ power system when not in use.

- Charge the Pure³ energy storage system to greater than 80% SOC as indicated on the SOC gauge in the vehicle.
- Turn OFF all vehicle electrical features powered by the Pure³ system. This includes DC and AC electrical features in the vehicle as well as the inverter/charger by their control switch or display.
- With the vehicle engine off and the shoreline unplugged, press the Pure³ energy storage pack ON/OFF button. When you turn the button off, the green light on the button may stay on for a period of time while the system shuts down all components. This can last up to a couple minutes. The gauge may blink blue

momentarily during this time. You will know the pack is properly shut down when the lights on the button and gauge are completely off. At this time power should no longer be available from the system. The Pure³ energy storage pack is now deactivated and the power distribution devices are off.

NOTICE

During long-term storage, Volta recommends the energy storage pack be turned on every 3 months. to ensure the Volta energy storage pack maintains a charge above 49.7 volts as read from the Volta inverter/charger display.

NOTICE

Long term storage without maintaining the correct voltage will reduce the life of the pack and possibly destroy the pack permanently.

NOTICE

Improper storage is not covered under warranty.

NOTICE

Overnight temperatures can go to as low as -40°C/-40°F during storage as long as the average temperature for any 3 month time period does not exceed the temperature range of -20°C/-4°F to 45°C/113°F.

NOTICE

If a Volta energy storage pack is stored in deep sleep in a low charge/low voltage state (<49.72V) for an extended period of time, permanent damage to the Volta energy storage pack may result. Neglecting system maintenance and allowing a Volta energy storage pack to come to this state will result in voiding the warranty for the Volta energy storage pack.

NOTICE

During the up-fit of the Pure³ Power System the chassis manufacturer's drive belt has been changed to accommodate added charging equipment. The new belt part number for the chassis is 6PK2185 and for the Pure³ Power System is a 6PK1360.

NOTICE

Failure to turn off Volta pack will prevent the pack from entering deep sleep mode. Even with no loads on the system, and assuming a fully charged pack, this will cause the pack to deplete faster, in as short as 60 days, which can cause permanent damage to the Volta energy storage pack. The depletion rate accelerates further under cold conditions when the automatic heater engages. Allowing a Volta energy storage pack to come to this state will result in voiding the warranty for the Volta energy storage pack.

Safety Recommendations

- Do not disassemble any of the components of the Pure³ Power System.
- Do not drive through flooded areas or deep water.
- Do not incinerate the Pure³ Power storage pack.

SECTION 7 – PLUMBING

FRESH WATER SYSTEM

The Fresh Water System provides water to the galley sink, shower, bathroom lavatory, toilet, and water heater. Water may be supplied by either of two sources:

- A fresh water tank and water pump located within the motorhome, or
- Any external fresh water source to which the motorhome may be connected, known as “city water”.

The fresh water tank on your motorhome is filled using the Tank Fill Inlet on the Water Center Panel.

Water Pressure Regulators

Because city water pressure varies from location to location, we recommend obtaining an in-line water pressure regulator to prevent damage to any components, connections, and seals in your fresh water system.

These devices simply connect in-line between the supply hose and the city water input on the motorhome. We recommend regulators that control water pressure to **50 psi. max.**

Water pressure regulators are commonly available at most RV dealerships and many large retail discount or home supply centers.

Method 1 - Filling the Fresh Water Tank Through Tank Fill Connection

 WARNING
Potable water only. Sanitize, flush, and drain water tank before using. See owner's manual for instructions, care, and maintenance information. Failure to maintain tank can result in death or serious injury.

Always fill the fresh water tank at an approved potable water filling facility or a known purified drinking water source.

The tank is filled through the Tank Fill Inlet located on the Water Center Panel behind the passenger rear door.

1. Attach hose to the Tank Fill Inlet.



Tank Fill Inlet
(Located behind the passenger rear door on the 59KL, and behind the drivers rear door on the 59GL.)
*Model 59KL Shown
-Typical View

2. Configure the levers on the panel to reflect the “Power Fill Tank” setting as indicated by the picture instructions on the Water Center Panel.

NOTICE
Do not leave fresh water connection unattended when filling tank. Failure to comply may result in tank expansion and property damage.

3. Turn OFF city water supply and disconnect hose from the Tank Fill Inlet.
4. Set the Water Panel back to the “Dry Camping” setting.

SECTION 7 – PLUMBING

EXTERIOR UTILITY LIGHT SWITCH

There is an exterior light on the drivers side to illuminate the area around the water service center for dumping, showering, etc. It can be turned on with the switch located on the Water Center Panel.



Exterior Utility Light Switch
(Located in the Water Center Panel.)
*Model 59KL Shown
-Typical View

ECO-HOT SYSTEM

When placed in the “Pre-heat” setting the Eco-hot System cycles water as it gets hot, to avoid wasting water into the gray tank. To operate, turn the water pump on, then turn the Eco-hot valve to the “Pre-heat” position. After approximately 6 seconds, the water should be hot. Then place the Eco-hot valve to the “Normal” position.



Eco-hot valve

- Model 59KL: Located drivers side on the sink.
- Model 59GL: Located passengers side on the sink.

*Model 59KL Shown
-Typical View

WATER PUMP

When your motorhome is not connected to a city water supply, water is supplied from the fresh water tank by a water system demand pump. A demand pump is designed to run only when you are using water. When you open a faucet, the waterline pressure drops and the pump begins to run, and it will continue to run as long as the faucet is open. When you close the faucet, the line pressure backs up to the pump, and it shuts itself off.

The pump is self-priming and will run briefly to build up line pressure when the Water Pump switch is first turned on. See “Initial Waterline Priming” for instructions on using the water system for the first time.

Water Pump Strainer

The pump is equipped with a cleanable strainer to capture any possible tank-borne particles that could damage pump components.

NOTE: We recommend that you check and clean the strainer after each tankful of water during the first few uses of the Water Pump system. Thereafter, remember to

check it at least yearly, and be sure to empty water from it if using the blowout winterization procedure.



Water Pump Strainer
-Typical View

To Clean Pump Strainer

- Ensure all Water Pump switches are OFF.
- Twist the inlet cap (bowl) “counter-clockwise” to unscrew from the strainer assembly.
- Remove the bowl and pull the strainer screen out of the bowl to tap out any particles and rinse clean.
- Insert the strainer screen back into the bowl, then screw the bowl back onto the strainer assembly.

Water Pump Switch

The Water Pump switch is located on the top right of the Water Center Panel behind the passenger rear door.



Pump switch
-Typical View

While the switch is “ON”, the pump will automatically supply water as it is needed.

Do not leave the pump on while away from your motorhome or while driving. In time, a slow leak in a faucet could drain the water tank, fill the holding tank, and discharge the house batteries.

Initial Waterline Priming

1. Ensure that all water drain valves are closed, including water heater valve.
2. Turn Water Pump switch to “OFF” position.
3. Fill water tank.
4. Open all faucets, hot and cold.
5. Turn ON the Water Pump switch.
6. Close each faucet as it begins to deliver a steady stream of water (close cold water first). Leave hot water faucets on until they also deliver a steady stream of water. This will ensure that the water heater is filled with water.
7. Check to ensure the Water Pump stops soon after all faucets have been closed.
8. The Water Pump is now ready for automatic operation. The pump will start when a faucet is opened and stop when the faucet is closed.

Further Information

Refer to the Water Pump manufacturer’s operation, care, and maintenance information provided in your InfoCase.

SECTION 7 – PLUMBING

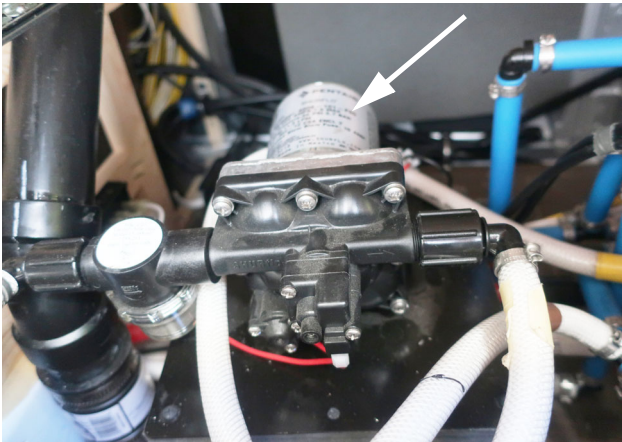

Water Pump

- Model 59GL: Driver side rear- remove drawer under the bed to access.
- Model 59KL: Passenger side rear- remove lower panel forward of the Water Center Panel.

*Model 59KL shown
-Typical View



Cold Water Filter Assembly

(Located inside lower galley cabinet on the 59GL, and located in the access panel under the bed in the 59KL)
-Typical View

NOTE: Hot waterline is not filtered.

COLD WATER FILTER

-If Equipped

To obtain filtered cold water for drinking or cooking, simply open the galley sink cold water faucet.

NOTE: Only the galley cold water faucet is filtered.

The cold waterline flows through an activated carbon filter that removes chlorine and odors for taste-free drinking water.

Replacing the Cold Water Filter Cartridge

You should replace the filter cartridge every season and when water flow from the faucet is too slow for convenience. The cartridge must be replaced at least every 12 months.

Further Information

See the water filter manufacturer's operation information in your InfoCase for filter cartridge replacement.

DISINFECTING YOUR FRESH WATER SYSTEM

(As required by NFPA® 1192 Standard on Recreational Vehicles)

To ensure complete disinfection of the potable water system, it is recommended that the following procedure be followed on a new system, one that has not been used for a period of time, or one that could have become contaminated.

This procedure is also recommended before long periods of storage, such as over winter.

Disinfecting with Sanitize setting

1. Turn the levers on the Water Center Panel to the “Sanitize” position as indicated by the picture instructions on the Water Center Panel.
2. Prepare a chlorine solution using 1 gallon of water and 1/4 cup of household chlorine bleach (sodium hypochlorite solution).
3. Attach a siphon tube to the tank fill port and turn the pump on to siphon the chlorine solution into the tank.



Attach a siphon tube then place it in the chlorine solution container and turn the pump on to begin siphoning contents.

*Model 59KL shown
-Typical View

4. Use 1 gallon solution for each 15 gallons of tank capacity. This procedure will result in a residual chlorine concentration of 50 ppm in the water system.

NOTE: If a 100 ppm concentration is desired, use 1/2 cup of household bleach with 1 gallon of water to prepare the chlorine solution. One gallon of this solution should be used for each 15 gallons of tank capacity.

WARNING

Chlorine is poisonous. Do not misuse. Recap bottle and clean all utensils after use.

5. Complete filling the tank with fresh water using the “Powerfill Tank” configuration on the Water Center Panel.
6. Turn off Heating System and allow to cool. See “Heating System - Furnace and Indirect Water Heating” in *Section 4 - Appliances and Systems*.
7. Configure the Water Center Panel in the “Dry Camping” configuration with one exception—place the RED lever in the horizontal position to bypass the water heater (see example below).



Modified Dry Camping mode to bypass the water heater.
-Typical View

8. Turn on the Water Pump.
9. Open each faucet in the motorhome and run the water until a distinct odor of chlorine can be detected in the water discharged. Do not forget the hot water faucets.
10. Let the system stand at least 4 hours when disinfecting with 50 ppm residual chlorine. *(If a shorter time period is desired, then a 100 ppm chlorine concentration should be allowed to stand in the system for at least 1 hour).*
11. Drain the water tank and refill with fresh water.

SECTION 7 – PLUMBING

12. Open each faucet again and run fresh water to flush chlorinated water from the lines. Run the water until there is no odor of chlorine detected in the water discharged. Do not forget the hot water faucets.
13. Turn water center panel to the city water configuration.
14. Turn on water heater.
15. Water system is now disinfected.

Disinfecting with Tank Fill

When disinfecting through the tank water fill, an external cartridge-type water filter assembly must be connected in-line between the city water hose and the tank fill inlet to add disinfecting solution to the tank. These filters are commonly available at most RV supply stores.

NOTE: If you do not have an in-line cartridge filter, see City Water Hose/Tank Disinfection following this procedure for an alternate method of adding bleach solution to your tank.

1. Turn off Heating System and allow to cool. See “Heating System - Furnace and Indirect Water Heating” in *Section 4 - Appliances and Systems*.
2. Turn the water center panel to the “winterize” setting as indicated by the instructions on the water center panel to bypass water heater to prevent filling the water heater tank with a high concentrate of chlorine.
3. Remove the filter cartridge and pour 1/4 cup of household chlorine bleach (sodium hypochlorite solution) for each 15 gallons of tank capacity into the empty filter canister, then screw the canister back onto the filter base.



WARNING

Chlorine is poisonous. Do not misuse. Recap bottle and clean all utensils after use.

This solution will result in a residual chlorine concentration of approximately 50 ppm in the water system. *(If a 100 ppm concentration is desired, use 1/2 cup of household bleach for each 15 gallons of tank capacity).* The bleach will be drawn into the tank when the city water is turned on.

4. Fill the tank completely, then open each faucet in the motorhome and run the water until a distinct odor of chlorine can be detected in the water discharged. Do not forget the hot water faucets.
5. Let the system stand at least 4 hours when disinfecting with 50 ppm residual chlorine. *(If a shorter time period is desired, then 100 ppm chlorine concentration should be allowed to stand in the system for at least 1 hour).*
6. Drain the fresh water tank.
7. Install the filter cartridge into the filter canister, then refill the tank with fresh water.
8. Open each faucet again and run fresh water to flush chlorinated water from the lines. Run the water until there is no odor of chlorine detected in the water discharged. Do not forget the hot water faucets. *(You may need to leave a hot water faucet open for some time to flush the water heater with clean water. You may also want to turn the water heater off until this is done to avoid wasting energy trying to heat “unused” water).*
9. Water system is now disinfected.

City Water Hose/Tank Disinfection

As an alternative way to disinfect your tank, connect a city water hose to your motorhome and pour the bleach into the other end of the hose using a funnel. Hold the hose upright to avoid draining the bleach.

Connect the hose to a city water hydrant to force the bleach into the tank and fill the tank with water.

This method has the additional benefit of disinfecting the city water hose at the same time.

Continuous Tank Disinfection (Superchlorination)

Some RVers like to ensure continuous sanitation of their fresh water tank by “superchlorination”– maintaining an effective low level of chlorine in the tank at all times.

- Add 1 teaspoon of household chlorine bleach (sodium hypochlorite) to your tank for each 10 gallons of tank capacity. When you fill the tank, this will result in a 6.7 ppm level of chlorine, which should kill harmful bacteria and slime-forming organisms.
- Chlorine may be removed from drinking water by the cold water filter at the galley faucet (if equipped) or by installing an activated carbon water purifier at the galley sink cold water line or a separate drinking water faucet with filter.
- Superchlorination does not affect city water usage, only the fresh water tank.

SHOWER VALVE PRESSURE BLEED-OFF

After using the shower, you may notice water dripping from either the shower head or the faucet assembly. The dripping results when vacuum in the shower hose (after closing the shower valve) slowly dissipates and allows water remaining in the hose to drain down. This is normal water pressure bleed-off function of the shower valve assembly and is not a leak or defect.

The International Association of Plumbing and Mechanical Officials: Standard TSC 21-85 (PAR. 4.3) states:

“Shower heads which incorporate shutoff valves, shall have a minimum “drip rate” of one (1) quart in thirty (30) minutes.”

SINK – LAVATORY (Model 59KL)

Because of the compact nature of this motorhome, the sink folds down to reveal a recessed space where the lavatory faucet is located.

The lavatory sink is located below the medicine cabinet behind the toilet.

- To open sink, pull the sink down away from the shower wall.



- Position lavatory faucet over the sink.



- The sink is now ready for use.
- Reverse steps to store lavatory sink.

SECTION 7 – PLUMBING

EXTERIOR SHOWER/WASH STATIONS

The exterior wash station feature allows you to do things such as rinse off sand or salt after a swim, rinse off muddy boots, or bathe your pet outside the motorhome. The water pump switch is located in the water center panel, inside the rear passenger door.

NOTE: The exterior wash station detachable hose is stored in the rear of the vehicle.

The shower/wash station includes hot and cold water (located inside the rear passenger side door).



Exterior Shower/Wash Station
(Located behind rear passenger side door on the 59KL, and behind the drivers rear door on the 59GL.)
*Model 59KL shown
- Typical View

TOILET

The toilet in your motorhome is very similar to the household type, except that it is designed to use only a small amount of water per flush. It uses a high velocity jet of water, producing a swirl effect, to efficiently cleanse the bowl.

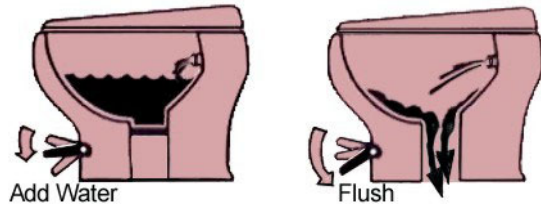

Important “Don’ts”

- Don't use facial tissue or regular toilet tissue in the RV toilet. These will not disintegrate sufficiently and will often cling to the sides of the holding tank. Toilet tissue made specifically for use in RV toilets and holding tanks is available at most RV supply centers.
- Don't dispose of sanitary napkins or other non-dissolving items in the toilet.
- Don't put automotive antifreeze or caustic chemicals, such as laundry bleach or heavy detergents into the toilet or holding tank. These products may damage plastic or rubber parts in the system.

See winterizing instructions at the end of this section to prepare the toilet for storage in freezing conditions.

Further Information

See the toilet manufacturer's operation information in your InfoCase for complete operating, care, and maintenance information.

WASTE WATER SYSTEM (MODEL 59GL)

(Holding Tanks)

The drainage system is self-contained and uses two separate holding tanks to contain the waste water until it can be dumped at an appropriate waste water disposal site. This means you can use the toilet, sinks, and shower even in areas where utility hookups are not available.

The black water holding tank contains the sewage from the toilet. The gray water holding tank contains the waste water from the galley sink, shower, and lavatory.

See “Specifications” in *Section 1 - Introduction* for tank capacities for your model.

Waste Pump (Model 59GL)

The 12-volt Waste Pump transfers gray holding tank waste through a small diameter sewer hose to the main dump valve.

To access the Waste Pump, use a screwdriver to remove the black plug shown in the following photo.



Waste Pump Enclosure
(Located beneath motorhome)

- Remove black plug to access waste pump

- Motor Shaft Access Plate



Waste Pump
(Located beneath motorhome)

- With black plug removed you will be able to remove the motor shaft access plate.

-Typical View

NOTE: If Waste Pump stalls, check breaker in the load center. If problem persists, remove black plug and motor shaft access plate; then manually turn pump shaft (located on the end of the Waste Pump) with a screwdriver.

Further Information

For further Waste Pump operating and troubleshooting information, see the manufacturer's user guide provided in your InfoCase.

Dumping Holding Tanks (Model 59GL)

1. Remove sewage drain hose from storage compartment (located on left sidewall).



Sewage Drain Hose
(Located beneath left sidewall)
-Typical View

2. Remove dust cap from sewage drain outlet and connect sewage drain hose. Be sure it is firmly attached.

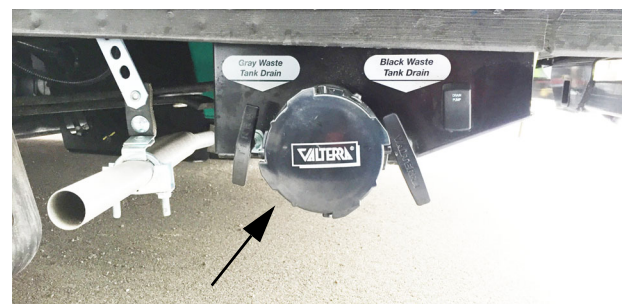

Sewage Drain Outlet
(Located beneath motorhome)
*Model 59GL

SECTION 7 – PLUMBING

- Place the outlet end of sewage drain hose into disposal opening.
- Open the Black Waste Tank Drain valve with a quick pull and make sure there are no sags in the hose. Close Black Waste Tank Drain valve as soon as tank is empty.

- 1st** - (Refer to Step 4) Pull Black Waste Tank Drain valve to drain black water (sewage tank, then close)

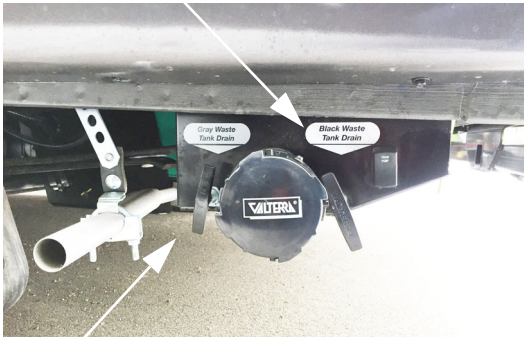

- 2nd** - (Refer to Step 5) Pull Gray Waste Tank Drain valve to drain gray water (sink/shower). Press and Hold Waste Pump switch until tank is empty. Close Gray Waste Tank Drain valve.

Black and Gray Waste Tank Drain Valves
(Located beneath motorhome)
*Model 59GL

NOTE: DO NOT OPEN BOTH VALVES AT ONCE. Do not open the Gray Waste Tank Drain valve until the black tank is drained and dump valve closed to avoid sewage back-up into gray tank. Gray water also rinses any black water solids from the sewage drain hose.

- Open the Gray Waste Tank Drain valve. Be sure there are no sags in the hose to ensure complete drainage. Press and Hold Waste Pump switch until tank is empty (do not run pump dry.) Close Gray Waste Tank Drain valve as soon as tank is empty.

NOTE: Sound of Waste Pump will change significantly when tank is empty.

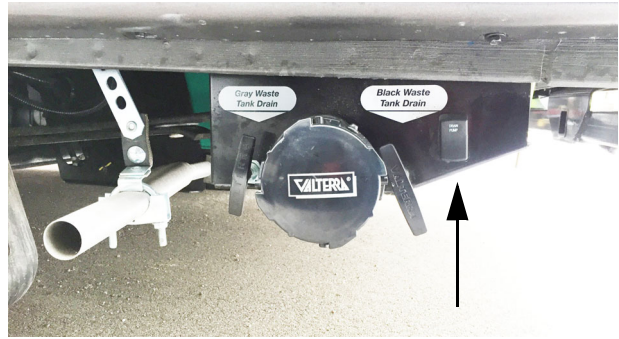

Waste Pump Switch
(Located beneath motorhome
near sewage drain outlet)
-Typical View

- Store sewage drain hose.
- Add an odor control chemical to the sewage holding tank through the toilet. These chemicals are available at most RV stores.

NOTE: We recommend that you dump all holding tanks before traveling to avoid carrying unnecessary weight.

Flushing Your Black Waste Holding Tank

The black waste holding tank is equipped with an internal spray head that allows you to rinse the inside of the tank with a shower of clean water after dumping.

 CAUTION
Do not use the tank flush inlet unless the fullway termination valve is in the open position. Can result in an unsanitary condition leading to illness or personal injury.

- Dump your black waste holding tank in the usual manner at an approved sewage disposal station.
- Leave Black Waste Tank Drain valve open while flushing tank.

3. Attach a garden hose from a city water hydrant to the Black Waste Tank Flush Inlet fitting on the Water Center Panel (This inlet is clearly marked separate from the City Water inlet).



Black Waste Tank Flush Inlet
(Located on Water Center Panel)
-Typical View

4. Turn the water on to begin flushing. Allow water to run for about three minutes.
5. Disconnect garden hose from flushing system and close Black Waste Tank Drain valve.

Using On-Site Sewer Hook-Ups

The sewage drain hose may remain attached to the sewage drain outlet while the motorhome is parked and connected to an on-site sewage hook-up.

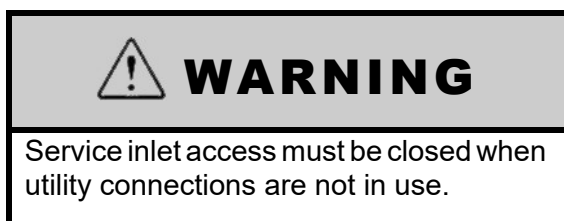

When using a sewer hook-up, keep the dump valves closed until a tank becomes full or when preparing to leave the site. This keeps the solids in suspension, allowing them to be carried out with the liquids when the dump valve is opened. If the valve is left open, the liquids will drain off, leaving solids in the tank. Should this accidentally happen, disconnect the hose, fill the

tank about half full with water, and drive a few miles to dislodge the solids. A few starts and stops will aid in the process. Then reconnect the hose and drain in the normal manner.

NOTE: Always keep sewage drain outlet capped while sewage connection is not in use.

Holding Tank Level Indicators

See “Systems Monitor Panel” in *Section 4 - Appliances* for further information on the monitor panel and checking tank levels.

See “Specifications” in *Section 1 - Introduction* for tank capacities for your model.

WASTE WATER SYSTEM (MODEL 59KL) (Holding Tanks)

The drainage system is self-contained and uses two separate holding tanks to contain the waste water until it can be dumped at an appropriate waste water disposal site. This means you can use the toilet, sinks, and shower even in areas where utility hookups are not available.

The black water holding tank contains the sewage from the toilet and bathroom lavatory. The gray water holding tank contains the waste water from the galley sink and shower.

See “Specifications” in *Section 1 - Introduction* for tank capacities for your model.

Dumping Holding Tanks (Model 59KL)

1. Remove sewage drain hose from storage compartment (located under the sliding door area).

SECTION 7 – PLUMBING

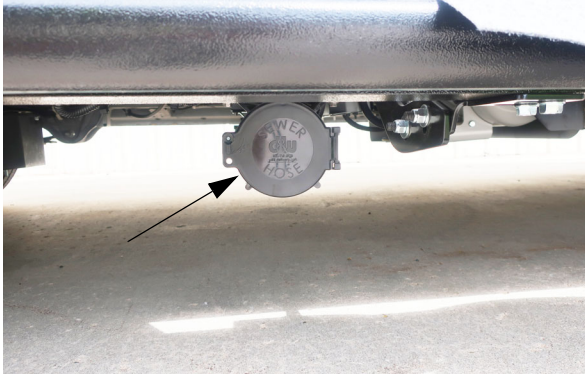

Sewage Drain Hose
(Located beneath left sidewall)
-Typical View

2. Remove dust cap from sewage drain outlet and connect sewage drain hose. Be sure it is firmly attached.



Sewage Drain Outlet
(Located beneath motorhome)
*Model 59KL
-Typical View

3. Place the outlet end of sewage drain hose into disposal opening.
4. Open the Black Waste Tank Drain valve with a quick pull and make sure there are no sags in the hose. Move the hose gently about to dislodge any waste and ensure complete drainage. Close Black Waste Tank Drain valve as soon as tank is empty.

- **1st** - Pull Black Waste Tank Drain valve to drain black water (sewage) tank, then close.

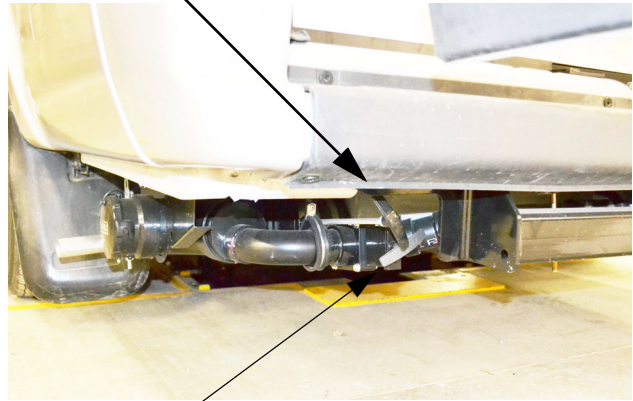

- **2nd** - Pull Gray Waste Tank Drain valve to drain gray water (sink/shower), then close.

*Model 59KL
-Typical View

NOTE: DO NOT OPEN BOTH VALVES AT ONCE. Do not open the Gray Waste Tank Drain valve until the black tank is drained and dump valve closed to avoid sewage back-up into gray tank. Gray water also rinses any black water solids from the sewage drain hose.

5. Open the Gray Waste Tank Drain valve. Be sure there are no sags in the hose to ensure complete drainage. Close Gray Waste Tank Drain valve as soon as tank is empty.
6. Add an odor control chemical to the sewage holding tank through the toilet. These chemicals are available at most RV stores.
7. Rinse sewage drain hose thoroughly with water before stowing.

NOTE: We recommend that you dump all holding tanks before traveling to avoid carrying unnecessary weight.

Flushing Your Black Waste Holding Tank

The black waste holding tank is equipped with an internal spray head that allows you to rinse the inside of the tank with a shower of clean water after dumping.

CAUTION

Do not use the tank flush valve unless the fullway termination valve is in the open position. Can result in an unsanitary condition leading to illness or personal injury.

WARNING

Service inlet access must be closed when utility connections are not in use.

1. Dump your black waste holding tank in the usual manner at an approved sewage disposal station.
2. Leave Black Waste Tank Drain valve open while flushing tank.
3. Attach a garden hose from a city water hydrant to the Black Waste Tank Flush Inlet fitting on the Water Center Panel . (This inlet is clearly marked separate from the City Water inlet).



Black Waste Tank Flush Inlet
(Located on Water Center Panel)
-Typical View

When using a sewer hook-up, keep the dump valves closed until a tank becomes full or when preparing to leave the site. This keeps the solids in suspension, allowing them to be carried out with the liquids when the dump valve is opened. If the valve is left open, the liquids will drain off, leaving solids in the tank. Should this accidentally happen, disconnect the hose, fill the tank about half full with water, and drive a few miles to dislodge the solids. A few starts and stops will aid in the process. Then reconnect the hose and drain in the normal manner.

NOTE: Always keep sewage drain outlet capped while sewage connection is not in use.

Holding Tank Level Indicators

See “Systems Monitor Panel” in *Section 4 - Appliances* for further information on the monitor panel and checking tank levels.

See “Specifications” in *Section 1 - Introduction* for tank capacities for your model.

4. Turn the water on to begin flushing. Allow water to run for about three minutes.
5. Disconnect garden hose from flushing system and close Black Waste Tank Drain valve.

Using On-Site Sewer Hook-Ups

The sewage drain hose may remain attached to the sewage drain outlet while the motorhome is parked and connected to an on-site sewage hook-up.

SECTION 7 – PLUMBING

TANK HEATERS

Your motorhome is equipped with black water, gray water, and water tank heaters to allow use of systems in freezing temperatures. The tank heater power switch is located near the monitor panel. The illuminated switch will glow when the power is on.



Tank Heater Switch
(Located near monitor panel)
-Typical View

DO NOT operate the tank heater for an extended time unless you are providing a supplemental 12-volt power source to recharge the Pure³ battery. This means either the shoreline cord must be plugged into a 120-volt source or the chassis engine must be running (such as when driving down the road or auto start active). This will prevent excessive discharge of the Pure³ battery.

NOTE: The tank heater pads are electrical resistant-type heating elements. This type of heating element typically uses a large amount of current while operating. If the tank heaters are used without a recharging source, they will drain the house battery in a relatively short period. Typically, the battery will not support overnight heating without a supplemental charging source.

WATERLINE AND TANK DRAIN VALVES

The waterline and tank drain valves are used to drain water from the water tank and the water supply lines when preparing the motorhome for storage or when sanitizing the water system.

See the “Water System Drain Valve Locations” chart at the end of this section for locations on your model.



Waterlines and Tank Drain Valves
*Model 59GL shown
(See “Water System Drain Valve Locations”
chart at the end of this section for location
on your model)
-Typical View

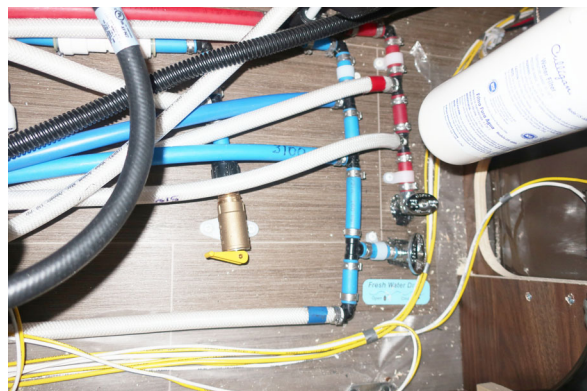

Waterlines and Tank Drain Valves
*Model 59KL shown
(See “Water System Drain Valve Locations”
chart at the end of this section for location
on your model)
-Typical View

WINTERIZING PROCEDURE

Your motorhome is equipped with a manually operated waterline winterization system for your convenience in winterizing fresh waterlines. This action is necessary for storage in cold climates. The winterization process blows out left over water in the pipes, and adds antifreeze to prevent pipes from freezing and bursting, possibly causing extensive damage. Certain areas of your water system require additional attention and disconnecting or blowing out these lines may be required. Be sure all water is drained from the system.

We recommend performing Step 1 “Blow Out Procedure” and Step 2 “Antifreeze Fill Procedure” to properly protect the system.

Step 1 – Blow Out Procedure (Drain and purge waterlines using compressed air)

1. **Level the Motorhome.** If the motorhome is not level, there may be “low points” in waterlines that can trap water in the lines and prevent it from draining properly.
2. **Set the Water Center Panel to the “winterize” configuration as instructed on the water center panel (located behind the passenger rear door).** Leave it in this configuration for the entire winterization process. The sticker located on the Water Center Panel shows all of the settings that it can be configured in.



Water Center Panel in
“Winterize” configuration (Panel
located behind passenger rear door)
*Model 59KL shown
-Typical View

3. **Turn OFF the Heating System and water pump by using the control panel (located near the monitor panel).** The water pump can also be switched off at the Water Center Panel (located at the top right of the panel). This switch can be turned off at either station, for convenience. (The switch at the Water Center Panel will illuminate if the pump is on).



Water heater controls on
Systems Monitor Panel
*Model 59KL shown
-Typical View

SECTION 7 – PLUMBING



Water pump switch location
on Systems Monitor Panel
*Model 59KL shown
-Typical View

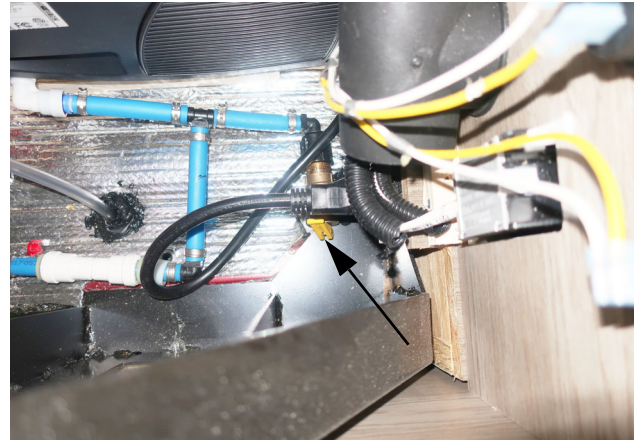

Water Heater Drain (Yellow) Valve
• Model 59GL: located beneath the forward facing
dinette seat.
*Model 59GL shown
-Typical View



Water pump switch location
on Water Center Panel
*Model 59KL shown
-Typical View

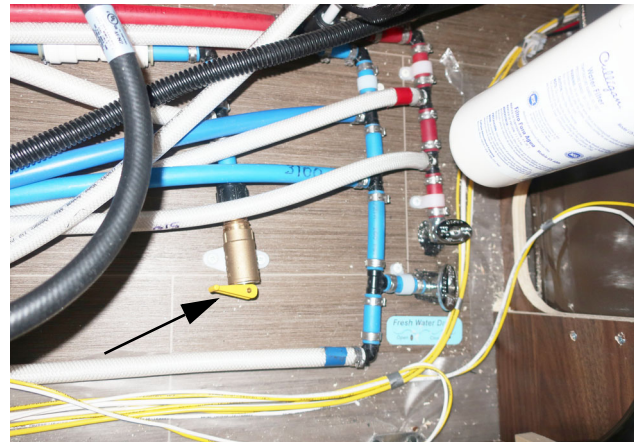

Water Heater Drain (Yellow) Valve
• Model 59KL: located in drivers side under the bed-
remove panel to access.
*Model 59KL shown
-Typical View

4. Drain Water Heater.

- Turn OFF the Heating System by using the control panel (located near the monitor panel).
- Open the Water Heater Drain (Yellow) Valve.

NOTE: To make sure that all water drains properly from the water container, place a big enough vessel underneath the drainage socket of the drain valve (>2.64 gallons (10 liters)).

 **CAUTION**

Hot water can escape from tank causing injury. Operate drain valve only when the tank water is cold.

5. Remove the filter canister from the Cold Water Filtration System and discard the filter cartridge. Reinstall after emptying the canister. The filter is located in the lower galley cabinet on the 59GL, and located in the access panel next to the bed in the 59KL.



6. Empty the water pump strainer filter bowl to avoid water freezing and cracking the filter bowl. See “Water Pump” previously in this section for the location on your motorhome.



To Clean Pump Strainer

- Twist the inlet cap (bowl) “counter-clockwise” to unscrew from the strainer assembly.
- Remove the bowl and pull the strainer screen out of the bowl to tap out any particles and rinse clean.
- Insert the strainer screen back into the bowl, then screw the bowl back onto the strainer assembly.

-Typical view

7. **Connect Air Pressure. Connect Air Pressure.** Connect a “blow-out” plug to the city water inlet (located on the lower left of the Water Center Panel). Then, use a compressed air hose regulated to 30 psi or less to force air through the system.

A “blow-out” plug can be purchased at any Winnebago Industries® dealer.

SECTION 7 – PLUMBING

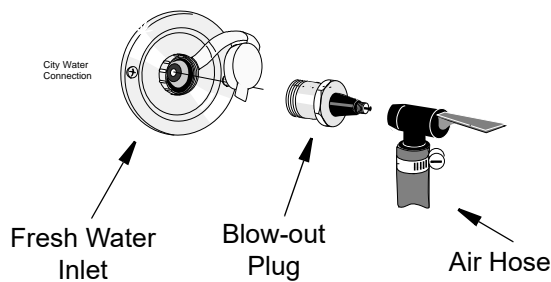

NOTICE

Limit air pressure to 30 psi to avoid damage to equipment.

NOTE: DO NOT burst air into the system. This can damage the water pump. It is better to let air in slowly.

8. Drain Exterior Shower/Wash Station.

Attach exterior shower hose, then point shower hose toward ground and squeeze handle. Turn on the hot faucet, then the cold to drain any water left in the shower line.



- Connect shower hose to Water Center Panel faucet (Located behind the passenger rear door), then squeeze handle until water stops flowing. (Model 59KL shown)
-Typical View
-Typical view

9. Drain Toilet.

Press the toilet flush pedal and hold until water stops flowing in the toilet.

10. Point the toilet sprayer into the toilet and squeeze handle to drain any water.
11. Open lavatory hot water faucet followed by the cold faucet until water stops flowing, then close.
12. Point shower head into lavatory sink and open shower faucet (point towards hot, then cold) until water stops flowing, then close.
13. Open galley sink faucet (point towards hot, then cold) until water stops flowing, then close.
14. **Drain Fresh Water Tank and Waterlines.** Open all waterline drain valves and drain fresh water tank. (See “Water System Drain Valve Locations” chart at the end of this section for locations of drain valves on your model).
15. **Turn air pressure off.** Disconnect blow-out plug.

After Disconnecting Air Pressure

16. Close all waterline and tank drain valves, and all faucets to avoid contamination by dirt, insects, or rodents.
Leave the Water Heater Drain (Yellow) Valve open until the winterization process is complete or the system is placed back into service.
17. Remove the Cold Water Filter Canister under the galley sink. Reinstall after emptying the canister.

Dump and Clean Holding Tanks

18. Completely drain the waste water holding tanks at an approved waste disposal site. Drain the sewage (black) tank first so the following waste water can rinse any waste solids from the dump outlet and sewage drain hose.
19. Attach a garden hose from a city water hydrant to the Black Waste Tank Flush Inlet fitting.
20. Turn the water on to begin flushing. Allow water to run for about three minutes.

21. Disconnect garden hose from flushing system, allow water to drain from port, then replace cap.
22. Close waste tank drain valves and refit the dust cap onto the sewage drain outlet. This will inhibit rust formation on valve shafts and prevent entry and contamination by airborne debris, insects, and rodents.
23. Continue with Step 2 - Antifreeze Fill Procedure.

Step 2 – Antifreeze Fill Procedure (Fill plumbing lines with RV water system antifreeze)

NOTE: Non-Toxic RV water system antifreeze is available from your dealer and from most RV supply stores and national retail outlets. Follow directions on the container to determine the correct amount to use for your motorhome.



WARNING

NEVER use automotive antifreeze/coolant in your RV water system. Automotive coolant/antifreeze contains ethylene glycol which, if ingested, can cause blindness and can be fatal.

The Water Control Panel features a Winterization (diverter) valve with an antifreeze siphon tube to draw non-toxic RV water system antifreeze into the waterlines.

24. Double check that the water control panel is set to the “winterize” configuration as indicated on the water control panel.

25. Attach antifreeze siphon tube on the Water Center Panel.



- Antifreeze Siphon Tube attached to the tank fill inlet
*Model 59KL shown
-Typical view

26. Insert the end of the siphon tube into a pail or other container with 2 to 3 gallons of non-toxic RV antifreeze solution.

NOTE: Ensure that all drain valves are CLOSED before pumping RV antifreeze into the water system. Refer to the “Water System Drain Valve Locations” chart at the end of this section for valve locations on your model.

Fill Lines

27. Turn the Water Pump switch ON.
28. Open each hot and cold water faucet handle/knob in the motorhome - one at a time each in turn until antifreeze solution just begins to flow from the faucet, then close.
29. With the exterior shower/wash station hose connected, point hose toward the ground and squeeze handle until antifreeze solution begins to flow, then disconnect hose.
30. Press the toilet flush pedal and hold until antifreeze begins flowing into the toilet. Leave small amount of antifreeze that remains in the bowl.

SECTION 7 – PLUMBING

31. Open city fill inlet. Place the tip of your finger into the city water inlet and gently press the backflow valve “button” in the center of the inlet to drain any water trapped in the inlet line.

Replace city fill inlet filter. Recap the city water inlet to avoid contamination by dirt or insects.

32. Disconnect Antifreeze siphon tube.

When Done Adding RV Antifreeze

33. Turn Water Pump switch OFF.

34. Leave the Water Control Panel in the “Winterize” configuration until you are ready to bring the motorhome out of storage.

35. Replace the protective cap onto the end of the Antifreeze Siphon Tube to keep out insects and debris when not in use.

Fill Drainage System P-Traps

36. Pour about one cup of RV antifreeze down each drain for the galley sink and lavatory sink. This fills the drain trap pipes to prevent holding tank odors from entering the motorhome during storage.

Your drainage and fresh water systems are now winterized.

See instructions for removal from storage in Section 11 - Maintenance and Storage.

WATER SYSTEM DRAIN LOCATIONS		
Model	System	Drain Valve Locations
59GL	Waterline Drain Valves	<ul style="list-style-type: none"> • Two (2) drain valves located under the shower- remove magnetic panel to access. • Open exterior shower faucets and lay shower head on ground. Open spray nozzle until drained <i>Place the tip of your finger inside the city water connection and gently press the backflow valve (small “button” in center of connector) to drain cold water from the city waterline.</i>
	Water Tank Drain Plug	<ul style="list-style-type: none"> • One (1) plug on bottom of water tank beneath chassis located on driver side just in front of the rear axle.
	Water Heater Drain Valve	<ul style="list-style-type: none"> • One (1) yellow drain valve on inside of motorhome beneath forward facing dinette seat. Remove panel to access.
59KL	Waterline Drain Valves	<ul style="list-style-type: none"> • Two (2) drain valves on the drivers side under the bed- remove panel to access. • Connect hose to port and lay shower head on ground. Open spray nozzle until drained. <i>Place the tip of your finger inside the city water connection and gently press the backflow valve (small “button” in center of connector) to drain cold water from the city waterline.</i>
	Water Tank Drain Plug	<ul style="list-style-type: none"> • One (1) plug on bottom of water tank beneath chassis located on driver side just in front of the rear axle.
	Water Heater Drain Valve	<ul style="list-style-type: none"> • One (1) yellow drain valve on the drivers side under the bed- remove panel to access.

SECTION 8 – ENTERTAINMENT

TV – (SWING-OUT) (Model 59GL)

Your motorhome may be equipped with a TV swing-out mechanism, which allows you to angle the TV to best suit your viewing needs.

NOTE: To operate the TV, the motorhome must be connected to shore power, the inverter turned on, or the generator running.

To Swivel TV

1. Pull the black strap (located on back side of TV) straight DOWN to release the TV from the mounting bracket.



Pull straight down to release
-Typical View

2. Pull the TV out and pivot to desired position.
3. Rotate TV back to center position and press straight back towards wall. You will hear a “click” when the TV is secured into locked position.

Further Information

See the television manufacturer’s user guide provided in your InfoCase for complete operating instructions.

TV – SWIVEL (Model 59KL)

Your motorhome is featured with a TV swivel/telescoping mechanism, which allows you to angle the TV to best suit your viewing needs.

NOTE: To operate the TV, the motorhome must be connected to shore power, the inverter turned on, or the generator running.

To Swivel TV

1. Pull the black strap (located on back side of TV) straight DOWN to release the TV from the mounting bracket.



Pull straight down to release
-Typical View

2. Pull the TV out and pivot to desired position.
3. Rotate TV back to center position and press straight back towards wall. You will hear a “click” when the TV is secured into locked position.

Further Information

See the television manufacturer’s user guide provided in your InfoCase for complete operating instructions.

SECTION 8 – ENTERTAINMENT

AUDIO/VIDEO SYSTEM BASIC OPERATION

*NOTE: For your convenience, we have also included a handy, tear-out version of this “A/V System Basic Operation” guide in Section 8 of your Operator’s Manual Supplement.
See your InfoCase for specific operating guides for audio and video components.*

TV ANTENNA – DIGITAL

(Omnidirectional Digital HDTV Over-the-Air Antenna)

Your motorhome is featured with a omnidirectional digital antenna, which provides crystal clear digital HD reception of over-the-air channels in addition to superior broad reception range.

The digital antenna is equipped with a built-in amplifier for maximum VHF and UHF programming.

A built-in signal amplifier designed to strengthen signals, is controlled by a power switch built into the optional video selector panel or on a wall plate assembly.



WARNING

Never allow the antenna to touch electrical power lines or any other electrical wires.

Operating the Digital Antenna

- Turn the Digital Antenna Power Switch ON.

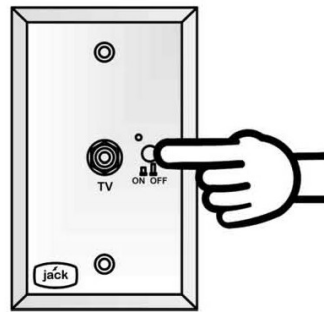

Digital Antenna Power Switch
(Located in an overhead cabinet or mounted on a wall near the TV)

NOTE: Refer to television manufacturer’s instructions to scan for available channels.

Further Information

See the antenna manufacturer’s user guide provided in your InfoCase for complete operating and maintenance information.

TV SIGNAL AMPLIFIER

The TV Signal Amplifier is built into the antenna and can be turned on or off with a power switch.

An indicator light will illuminate when the switch is on and the signal amplifier is active.



TV Signal Amplifier Power Switch
(Located in an overhead cabinet or mounted on a wall near the TV)
-Typical View

CABLE TV CONNECTION

The cable television input connection is located on the left sidewall.

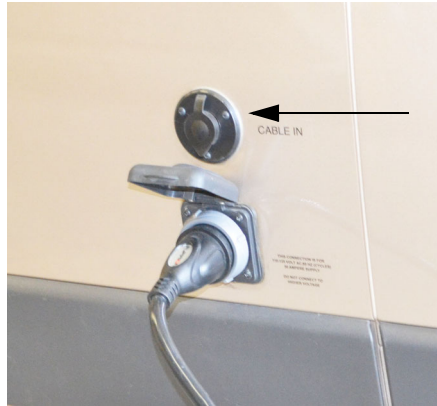

Cable TV Input Connection
(Located on the left sidewall)
*Model 59GL shown

EXTERIOR CABLE TV – 12V CONNECTION

–If Equipped

The exterior cable TV/12-volt connection receptacle on your motorhome provides connection for use of a TV and/or 12-volt device for your outdoor entertainment.

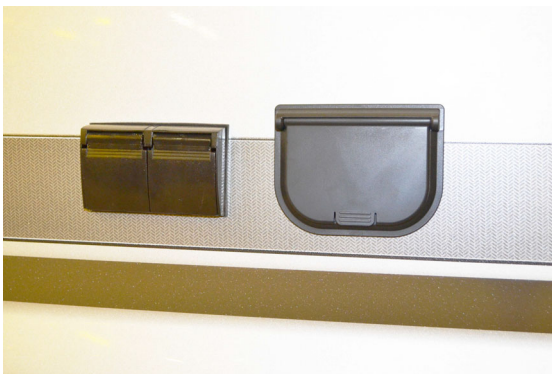

Exterior Cable TV / 12-Volt Connection
(Located on passenger sidewall)
-Typical View

AUDIO/VIDEO SYSTEM CONNECTION

–If Equipped

An HDMI Connection is provided inside a cabinet near the TV for connection of your choice of DVD player, home theater system, or satellite receiver.

The cable is connected to the lounge TV.



HDMI Connection
(Located in a cabinet near TV)
-Typical View

SECTION 8 – ENTERTAINMENT

ACCESS PORT (ROOF)

Your motorhome is equipped with a roof access port that provides a wiring path from an overhead cabinet to a sealed box on the roof for installing electronic devices such as Wifi and cell boosters, TV antennas, and satellites.

The roof access port is located inside the passenger side overhead cabinet. Remove plug to access.



Roof Access Port
-Typical View

SECTION 9 – FURNITURE AND SOFTGOODS

SLEEPING FACILITIES



WARNING

Sleeping facilities are not intended for use while vehicle is in motion. For safety, passengers must use safety belted seating positions while vehicle is in motion.

DINETTE TABLE

(Model 59GL)

(Typical View – Your motorhome may differ in appearance)

How to set up the dining table

1. Lift the table up from the bottom.



2. The table will lock in place.



3. To place the table back into storage, pull back on the plastic loops to unlock and lower back down.

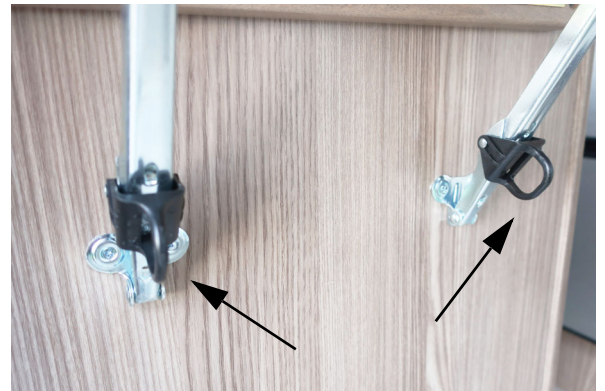

DINETTE TABLE (PORTABLE)

(Model 59GL)

(Typical View – Your motorhome may differ in appearance)

Your motorhome is equipped with a portable dinette table, which can be adjusted and attached to 2 included brackets. The table has 3 adjustment levers that alter the height, length, and position of the table. Rotate the lever counter-clockwise to loosen for adjustment, and rotate clockwise to tighten. If the lever gets in the way, you can pull out on the lever to free spin it to a position that can be tightened again. To

SECTION 9 – FURNITURE AND SOFTGOODS

remove the table, loosen the lower lever and raise the table past the maximum height and the table will slide off.



Dinette shown attached to the drivers side wall.
-Typical View



The second dinette table attachment point is located inside the passengers wall next to the main entry door.
-Typical View



There are 3 adjustment levers that alter the height, length, and position of the table.
-Typical View

BED

(Model 59GL)
(Typical Views – Your motorhome may differ in appearance)



The bed is located on the drivers side rear, folded up and locked with a seatbelt for storage.
-Typical View

Lowering the bed for use

1. Release the seat belt that holds the bed in the storage configuration

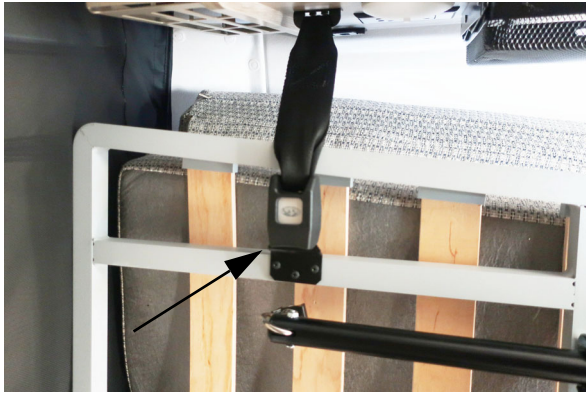

2. While lowering the bed, lower the support legs



1. The bed should look like this fully lowered with support legs straight.



1. Unfold the mattress to complete. Reverse the steps to put the bed back into the storage configuration



BED – DELUXE SLEEP SYSTEM
(Model 59KL)
(Typical Views – Your motorhome may differ in appearance)

Bed Conversion

1. The bed in storage configuration.



SECTION 9 – FURNITURE AND SOFTGOODS

2. Locate the slide out bed frame under the drivers side mattress and pull out.

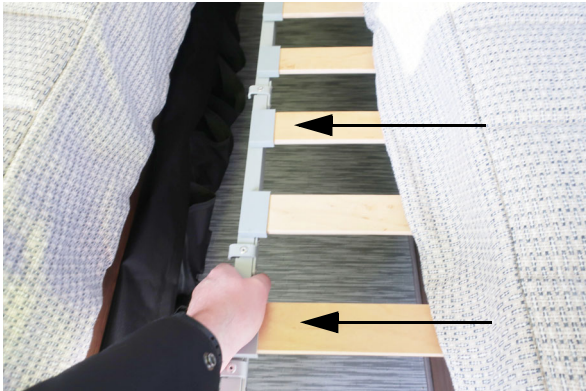

3. The slide out bed frame interlocks with the frame underneath the passengers side mattress shown below.



4. Place the loose cushions into the gap made by the slide out bed frame. Reverse the steps to put the bed back into the storage configuration.



WINDOW SHADES/SCREENS

–If Equipped

(Typical View – Your motorhome may differ in appearance)

Your motorhome is featured with multi-positioning window shades and screens that can be used for light filtering, outside airflow, bug protection, daytime room darkening, or nighttime privacy.

• Translucent Screen



• Shade

- To lower translucent screen, pull the bottom of the screen straight down until the bottom latch “clicks” into position.
- To raise the translucent screen, pull bottom latch outward and raise the screen.
- For daytime room darkening or nighttime privacy, pull entire shade upward to desired position.

WINDOW SHADES

–If Equipped

(Typical View – Your motorhome may differ in appearance)

Your motorhome is featured with window shades that can be used for daytime room darkening or nighttime privacy.



- For daytime room darkening or nighttime privacy, pull entire shade upward to desired position.

WOOD FURNITURE AND CABINETS

–If Equipped

People are drawn to the natural beauty of wood. At Winnebago Industries®, our craftsmen work with the art found in each piece of wood to create cabinets of superior quality, backed by the Winnebago Industries warranty.

- Oak is a strong, open-grained hardwood that ranges in color from white to pink and reddish tones. Streaks of green, yellow, and even black may appear due to mineral deposits. Oak may also contain wormholes and wild, varying grain patterns. This distinct graining is considered a desirable quality and has made oak one of the most popular woods used for cabinetry.
- Maple is a close-grained hardwood that is predominately white to creamy-white in color, with occasional reddish-brown tones. While maple typically features uniform graining as compared to other wood species, characteristic markings may include fine brown lines, wavy or curly graining, bird's eye dots and mineral streaks. These traits are natural and serve to enhance maple's natural beauty.

- Cherry is characterized by its red undertones, but may vary in color from white to a deep, rich brown. Cherry is a close-grained wood with fairly uniform texture, revealing pin knots and curly graining. All wood will age with time and the finish will darken. This is especially true for cherry. This is a sought-after quality in cherry cabinetry, and those who select it expect this evolution.

No matter which species you chose for your new Winnebago Industries motorhome cabinetry, please keep in mind that no two pieces of wood are exactly the same.

Stains are likely to exaggerate the difference between open and closed grains and other markings in wood. Grain variation and color change should be expected. As hardwood ages, it will darken when exposed to different types of light. Color differences or changes in wood can also be caused by exposure to harsh chemicals, extreme heat, or other contributing external conditions.

Any color change that occurs in both the finish and the wood is considered part of the natural aging process and is not to be considered defect or damage.

Additionally, wood species exhibit other defining characteristics, such as mineral deposits/streaks, knots, sap runs, pin holes, and wormholes. These markings make the wood unique and contribute to its enduring beauty.

Therefore, since wood is a product of nature and will have certain natural characteristics and variances, they are not covered under the warranty.

SECTION 10 – MAINTENANCE AND STORAGE

SEALANTS – INSPECTION AND GENERAL INFORMATION

Water is a recreational vehicle’s worst enemy when it is allowed to enter where it is not intended. Sealants perform a very important function and should be inspected closely and maintained regularly. Winnebago Industries® utilizes many different types of sealants. Refer to the “Sealants Call-Out Sheet” provided in your InfoCase for further information.

Sealants, in general, do not have “set” lifetimes. Varying environmental factors affect the pliability and adhesiveness of sealants. You or your dealer must:

- Inspect all sealants, a minimum of every six months.
- Inspect the moldings, windows, clearance lights, exterior compartment doors, and all their attachments.
- Also, inspect weather seals around entrance door, etc., and if necessary, have a dealer replace them immediately.
- Check for cracks, voids, gaps, breaks, adhesion, and any sign of physical deterioration.

NOTE: Proper sealant inspection includes not just visual observation but running a finger along sealant seams to verify proper adhesion to the surface. Any loosened areas must be replaced.

- Have the sealant replaced if you notice any of the above. Your local Winnebago Industries dealer has the correct and necessary parts and experience to help you maintain your sealants. See “Sealants Call-Out Sheet” provided in your InfoCase.
- Always use the same type sealant that was removed.
- Immediately have dealership check moldings, windows, and exterior attachments for leak source if you notice water inside of unit.

NOTICE

Sealants must be inspected every 6 months and replaced if necessary.

ROOF



WARNING

STAY OFF ROOF. Surface may be slippery. Falling could result in death or serious injury.

For your safety, it is not recommended that you store or carry items on the roof.

Always have damage to the roof area repaired immediately. Damaged or detached sealant around the vents, air conditioner, body-to-roof seams, etc., should also receive immediate attention. Delaying these repairs may allow water leakage and result in damage to interior ceiling and body panels, upholstery, etc., which is not covered by the limited warranty (see “New Vehicle Limited Warranty” provided at the beginning of this manual).

UNDERCARRIAGE

Buildup of mud and dirt under the body of the vehicle can cause damaging rust or corrosion on steel or aluminum parts and can add needless weight to the vehicle. This, in effect, reduces the amount of cargo you can carry and remain within GVWR and GAWR limits.

Corrosive materials, such as those used for ice and snow removal and dust control, can also accumulate on the underside of a vehicle. These materials should be removed by flushing the

SECTION 10 – MAINTENANCE AND STORAGE

undercarriage regularly with water, especially horizontal surfaces, cavities, and other areas where mud and other deposits may collect.

EXTERIOR AUTOMOTIVE PAINT FINISH

The exterior finish of your motorhome is fully or partially finished with the highest quality automotive paint and clearcoat.

Follow these precautions to keep the finish looking its best and preserve maximum gloss and durability.

Parking

- **Avoid parking under trees** – When this happens you should rinse the bird droppings and tree sap off as soon as possible. Tree sap is a form of sugar and will dissolve after a couple of rinses. Bird droppings can eat into a painted surface if left unattended and need removed as soon as possible. Lukewarm soapy water can help speed up the cleaning process.
- **Avoid parking near salt spray** – When this happens you need to rinse off the salt mineral residue to minimize the corrosiveness of the salt.
- **Avoid parking near factories with heavy smoke or industrial fallout** – Industrial fallout can eat into your exterior finish when dew or rain mixes with it to create nitric or sulfuric acid that gets magnified by the intensity of the sun. As the water evaporates, the acid becomes more powerful and attacks the painted surface. Rinsing and washing the surface helps remove the fallout and neutralize the acid. After the initial 60-day cure stage, a coat of wax or polish can help protect the surface from these types of contaminants.
- **Do not scrape ice or snow from the painted surface.** Brush off gently with a soft-bristled snow brush – avoid being forceful with the brush. If brush scratches show after the motorhome

thaws out, it may be possible to remove them by hand waxing with a silicone-free liquid wax.

- **Avoid covering painted surface.** When paint is covered (especially in outdoor conditions), water may appear between the cover and the motorhome due to rapid temperature fluctuations. The water may vaporize under certain conditions and migrate into the painted surface, possibly resulting in blisters and/or bubbles in the paint. These blisters/bubbles are not covered under warranty. Covering your motorhome is at owner's risk.

Driving

- Rinse off bugs and bird droppings with water daily.
- Antifreeze, fuel, or windshield/window solution spilled on the painted surface should be rinsed off immediately with water and allowed to air dry. Wiping dry with a towel may create fine scratches due to the solvent nature of these types of fluids.
- Fuel cannot be diluted and dissipated with water. It must be removed with a mineral spirit type cleaner (such as *SEAFOAM Bugs-B-Gone*, or equivalent) or a silicone-free spray wax and microfiber cloth to remove the stain left by fuels.
- Ensure that all motorhome fluids (such as gas, oil, grease, antifreeze, transmission fluid, brake fluid, etc.) are completely wiped off of painted surfaces. Failure to comply may cause the paint to blister and/or peel.

NOTE: When driving in wintry conditions, the road surface may be covered with heavy salts or small rocks to improve traction. These types of road conditions may cause surface damage to your motorhome. If possible, it is best to avoid these types of exposures. However, if you do use your motorhome under these types of conditions, you may want to consider, among other things, washing both the

undercarriage and the body of your motorhome after exposure to these types of conditions.

Washing

- Commercial vehicle wash facilities should be strictly avoided! They will scratch your motorhome!

Truck-style wash centers have high-pressure wands that emit higher than necessary water pressures and the brushes are very aggressive.

Most truck wash brushes are made from a heavy plastic for durability and are under heavy pressure. They are designed to clean heavy road films on semi trailers and are often dirty. They are not designed for custom painted motorhome's and they will scratch the clearcoat finish. Many times these scratches can penetrate the clearcoat finish, possibly causing delamination and/or other paint related issues that are not covered under warranty.

- Wash your motorhome with cool or lukewarm water using a quality automotive detergent that does not contain bleach solution. Most auto stores offer car wash detailing soaps that are similar and do not have bleach in the formulation (such as Meguiars #62).
- Never use a bristled brush or broom to wash the painted surface. This will cause scratches in the finish. Using a microfiber cloth, mitt, or mop is strongly recommended.
- Be sure your cloth or applicator is clean. A dirty applicator can scratch your motorhome.

Washing Procedure

- Rinse area to be washed with cold water to remove surface residue. Ensure you are not in direct sunlight.
- With area to be washed still wet from the rinse, use the recommended soapy mixture to clean the area. To avoid scratching painted surfaces, a microfiber cloth, mitt, or mop is strongly recommended to apply soapy water.

- Rinse washed area before soap evaporates.
- Dry the rinsed area before the water evaporates.

NOTE: Avoid aiming water flow from a hose or spray from high-pressure washing equipment into any appliance intake, as damage or difficulty in operating appliances may occur.

- After washing the motorhome, carefully inspect sealant around window frames, vents, and any other joints that may have loosened or separated. See “Sealants - Inspection and General Information” at the beginning of this section for details.

Bug Removal

- Rinse any loose debris off with water and allow the remaining residues to soak and soften. Use soap and water to wash the residue, then rinse.

NOTE: You may wish to repeat and leave soap on longer than normal to help with softening hardened residue.

- For more stubborn areas, use an ammonia-based glass cleaner followed by washing with warm soapy water, then rinse.
- Remember to use microfiber towels during this process to help avoid scratches.
- If this does not work, as a last resort, use a bug removal product (like SEAFOAM Bugs-B-Gone, or equivalent) in a shady area and follow the directions on label. Ensure cleaner is completely wiped off of painted surfaces. Failure to comply may cause the paint to blister and/or peel.

Polishing and/or Waxing

NOTE: When your motorhome is new or has been repainted for any reason, no polish or wax should be applied to the finish until after a 60-day cure cycle at temperatures higher than 60 degrees for 60 days. Failure to observe this precaution could void your paint warranty.

SECTION 10 – MAINTENANCE AND STORAGE

- We recommend a silicone-free polish with an orbital machine and terry cloth applicator.
- Liquid waxes are easier to apply and bring to a gloss with fewer residues.
- Avoid paste waxes. They sometimes have fillers and additives that give a very short term result. Stay away from silicones in polishes and soaps.
- Buffing compounds remove some of the mil film of the clearcoat, so we recommend that only professionals or very experienced users apply this type of product.

Inspection

A motorhome exterior is subjected to many physical forces and environmental conditions. While the motorhome is parked, it is exposed to climate and weather extremes and other environmental conditions. While in operation, it is subjected to various twisting and flexing forces caused by routine cornering and turning, and by uneven road surfaces, such as bumps, potholes, railroad tracks, and parking lot entrances.

Inspect the exterior fiberglass shell periodically for cracks which may represent a threat to the integrity of the fiberglass.

Minute cracks in the surface (commonly referred to as "spider cracks" or "hairline cracks") caused by normal flexing of the fiberglass exterior are normal and typically pose no threat to the integrity of the motorhome other than appearance.

However, if a crack has opened up and the weave of the cloth is visible, this does represent a threat to the integrity of the fiberglass and must be repaired or covered as quickly as possible to avoid penetration by moisture, especially in freezing climates.

If the fiberglass has been damaged and contains cracks, tears, or holes, use plastic sheeting and duct tape, if necessary, to prevent moisture from damaging the sidewall material or the interior of the motorhome.

Protective Film

–If Equipped

Your motorhome may be equipped with a protective film to defend against everyday road hazards. This film creates a barrier against bugs, road grime, bird droppings, and other harmful elements.

Further Information

See the manufacturer's information provided in your InfoCase for complete care and maintenance instructions.

EXTERIOR GRAPHIC CARE

The pressure-sensitive graphics on your vehicle require very little maintenance. In order to allow the graphics to have the longest life possible, the following steps should be taken.

- Wash graphics with plain soap and water or any car wash detergent. Rinse thoroughly.
- High pressure water spray may loosen or damage graphics. Keep spray nozzle at least 1 1/2 feet from the edge of the graphics.
- Test any cleaning solution on a small section of graphic before using.
- Never use aromatic solvents such as acetone, M.E.K., toluene, paint thinner or lacquer thinner on graphics. Solvents may soften the vinyl and smear colors.
- Gasoline or other fuels spilled on graphics should be rinsed off immediately with water.
- Do not apply paint or clearcoat over the graphics.
- Do not apply wax over the graphics, especially wax containing petroleum distillates. Wax that has dried along the edge of a graphic can be removed with cotton swabs after softening it with isopropyl alcohol. Rinse area thoroughly after cleaning.

PLASTIC PARTS – CLEANING

Many parts in your vehicle, such as the dash, exterior light lenses, and certain exterior body panels are made of high-impact plastic materials that can be damaged by wiping with solvents or improper cleaning products.

Always try cleaning plastic parts with the mildest cleaners first and work your way up to stronger cleaning products. Use the following cautionary lists as a guide when selecting cleaning products to use on plastic parts.

NOTICE

Do not use citrus-based cleaners on polycarbonate finishes. Citric compounds will damage the high-gloss surface, causing it to appear dull or “flat”. Always test a cleaning product on a hidden area to be sure it will not cause damage to the appearance of the part.

Here is a list of mild cleaners that **may be used safely**:

- Car washing soap and water
- Glass cleaners *without ammonia*
- Mineral oil
- Multipurpose cleaners (such as Fantastik[®], Formula 409[®], etc.)

The following products, compounds, or solvents must be **wiped off immediately** to avoid damage:

- Ammonia
- Brake fluid
- Bathroom basin, tub, and tile cleaners
- Chlorine
- Ethyl alcohol
- Isopropyl (rubbing) alcohol
- Kerosene or gasoline
- Naphthalene
- Pine-type household cleaners

Do not use cleaners containing the following products, compounds, or solvents. These products **will damage** the finish.

- Acetic acid
- Acetone (nail polish remover)
- Aromatic solvents (lacquer thinners)
- Benzene
- Butyl alcohol

EXTERIOR LIGHTS

Most Winnebago Industries[®] vehicles have polycarbonate lenses on exterior lamps, which are very sensitive to a variety of chemical solvents and cleaners.

Use only soap and water to clean exterior lamp lenses, especially headlights.

- Contact with certain chemicals can cause etching, “crazing” or cracking of the lens, which can significantly reduce the lens clarity and effectiveness of the lamp and may require replacement of the complete lamp housing.
- Some popular citric acid cleaners may cause polycarbonate lenses to become “hazy” or “foggy”.
- Do not use a pressure washer to clean headlights.
- Inspect and operate the lights regularly to confirm proper operation and mounting condition.

INTERIOR SOFT GOODS

We recommend a weekly routine of vacuuming all fabrics and carpet throughout the motorhome to prevent an accumulation of dirt, which can detract from the appearance and shorten the life of carpet and fabrics.

Fabric Upholstery

Some fabrics used in this motorhome may contain fire retardant and lightfastness additives, which can be damaged by use of improper cleaning products. Some water-based household cleaning products are not formulated for use on fabrics and may cause excessive shrinkage or

SECTION 10 – MAINTENANCE AND STORAGE

fading. Always test any cleaning product on a hidden area of fabric before using on visible areas. For best results, fabric cleaning should be referred to a professional carpet and upholstery cleaner.

NOTE: To minimize fading of upholstery, carpets and other interior fabrics caused by excessive sunlight, the drapes, blinds, or shades should be closed when the motorhome is parked for an extended period of time.

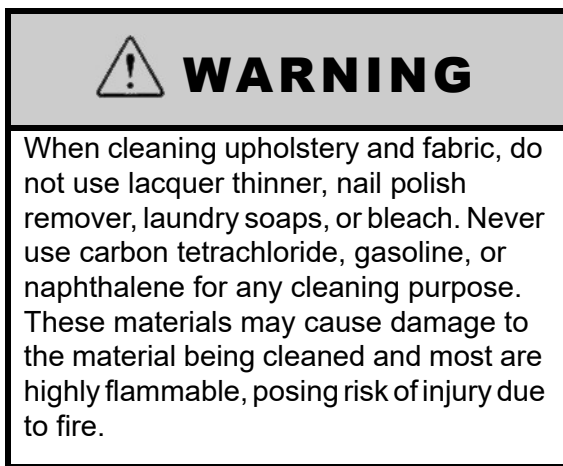

Leather Seats - Driver/Co-Pilot –If Equipped

- With a clean cloth or sponge, wipe up the spill immediately. If necessary, use clear, lukewarm water and gently wipe spill. Dry with a clean towel and allow to air dry. Do not use heat (such as a hair dryer) as you may damage the leather.
- For stubborn spots and spills, use a mild solution of Ivory[®] brand bar soap and clear, lukewarm water. Apply solution to a clean soft cloth or sponge and blot the area. Do not apply force or pressure, as you may damage the leather. Rinse and allow to air dry.

Do not use the following products. They will cause damage to the protective top coat of the leather.

- Saddle soaps, oils, abrasives, cleaners containing detergent (such as dishwashing liquids).
- Solvent-based cleaners (such as mineral spirits)
- Varnish or ammonia water, or silicone-based products.

Ultraleather™ Leather-Like Upholstery

Ultraleather synthetic leather fabric material has the luxurious look and feel of the finest European calfskin, with the durability and resistance to soils and stains of vinyl fabrics. It is also tougher than real calfskin and has superior resistance to punctures, snags, and rips.

For most soils and stains, the fabric manufacturer recommends spot treatment with a solution of water and Tide[®] brand laundry detergent or equivalent. More stubborn stains may be treated with a water-based multipurpose cleaner/degreaser such as Simple Green[®] or equivalent. Solvent cleaners such as nail polish remover or other aromatic solvents are not recommended.

Care Instructions

- Spot clean with mild soap and water.
- Air dry or, if desired, dry quickly using a hair dryer on warm setting - not hot.
- For stubborn stains, use cleaner-degreaser.

UltraLeather Cleaning Chart		
Type of Stain	Detergent/ Water	Cleaner/ Degreaser
Coffee, Tea	◆	
Red Wine, Liquor	◆	
Cola, Soft Drinks	◆	
Milk	◆	
Ketchup	◆	
Steak/Soy Sauce	◆	
Mayonnaise, Butter	◆	◆
Salad Oil	◆	◆
Chocolate	◆	◆
Cosmetic Makeup	◆	◆
Lipstick	◆	◆
Face Cream	◆	◆
Suntan Oil/Lotion	◆	◆
Shoe Polish	◆	◆
Urine	◆	◆
Machine Oil		◆

Vinyl Fabrics (including ceiling)

Vinyl should be cleaned with a soft, damp cloth, and a mild detergent only. Do not use solvents. Solvents may damage the surface of the vinyl.

Draperies, Curtains, and Bedspreads

These items may be woven from a variety of fabrics. We recommend that these be professionally dry cleaned only. A five percent shrinkage may occur when you have these items dry cleaned.

General Stains

As with any stain or contamination, the quick response is the best, especially when done in conjunction with the proper cleaner for the type of stain.

CABINETRY – CLEANING

Wooden items may be cleaned with a soft cloth and a good quality wood finish cleaning product.

Vinyl simulated wood panels may be cleaned with a mild, water-based cleaner and a soft cloth. Do not use solvents on vinyl wood panels.

NOTE: Many cabinetry and furniture items throughout this motorhome are constructed either partially or completely of real hardwoods. Because of natural variations in woodgrain density, slight differences in stain hue may exist between one item and another. This is the distinctive character and beauty of real wood.

DECORATIVE VINYL WALL PANELING – CLEANING

Decorative Vinyl Wall Paneling may be cleaned with mild detergent and warm water. The soap product should contain no abrasives, and the use of a soft cloth or sponge with the cleaning liquid should help preserve the finish of the vinyl.

Do not use bleach, cleaning agents with solvents or harsh chemicals, oil based spray cleaners, or other multipurpose cleaners such as Fantastik[®] or Formula 409[®] as they could damage the vinyl surface.

TABLES AND COUNTERTOPS

Work surfaces are covered with a plastic or thermo-formed laminate that resists solvents, stains, and abrasions. A coat of furniture wax applied to these surfaces on the counters and table will help preserve their beauty and make cleaning easier. Always clean the surface before applying wax.

SECTION 10 – MAINTENANCE AND STORAGE

SOLID SURFACE COUNTERTOP – CORIAN®

Care and Maintenance

You can easily maintain the beauty of your countertop with little effort, under most circumstances, by using warm soapy water or an ammonia-based cleaner (not window cleaner) then rinse and wipe dry. You can also use liquid or gel-type cleaners containing bleach. Because the material is nonporous, stains cannot penetrate below the surface and will nearly always disappear using these cleaning methods.

If a stain has dried on, allow the cleaner or soapy water time to soften the area, after which the stain will wipe off.

If the stain is not water-base or oil-base material, you may need to gently remove it using a plastic scraper (disposable plastic knife for example) followed by normal cleaning methods described above.

You may want to scrub the entire surface periodically. Do this lightly and evenly with a mild abrasive powdered or liquid cleaner.

Always use a cutting board rather than slicing foods directly on your countertop. The underside of one of your sink covers will provide an easily accessible cutting surface. This will keep your countertop looking its best and minimize care efforts. (An occasional sanding with a medium grade (120 grit) sandpaper will remove any cut marks accumulated on the sink cover bottom).

To remove cuts and scratches, use a more aggressive cleaning powder such as Comet®, a moistened steel wool soap pad, or green scouring pad. We recommend that you finish the entire surface using the same cleaning material and scrubbing method to maintain a uniform appearance.

If you prefer a glossier look, follow up with a good quality furniture polish or a liquid automotive wax (non-cleaner type).

Use trivets and “hot pads” under hot cooking pans. Do not set hot pots or pans directly from the stove or oven onto the counter. The solid

surface material is extremely heat resistant, but sudden contact by a very hot material with a cold countertop surface could cause a crack that would need to be repaired. Likewise, concentrated high heat sources in a small area, such as a crock pot or an electric griddle may cause a crack. We strongly recommend using a trivet under these. Also, do not allow candles to burn directly on the counter surface.

Avoid paint remover or oven cleaner. The solid surface material is also resistant to most chemical substances but exposure to some harsh chemicals and solvents such as these can cause damage that would need professional repair or replacement. If one of these materials does spill or drip onto the counter surface, wipe it up immediately to avoid damage.

SINK – STAINLESS STEEL

Care and Cleaning Instructions

The stainless steel sink can usually be cleaned with water and soap or detergent using a soft cloth or sponge.

- **Rinse thoroughly** with warm water and wipe dry quickly to avoid spots and streaks.
- **For stubborn stains**, use a mild abrasive cleanser like Soft Scrub®, Comet®, etc. Work in the direction of the “grain” of the brushed finish lines.
- **Never use steel wool.** Particles of steel from the wool pad can embed into the sink surface, then become rusty and unsightly.
- **Avoid contact with full-strength** bleaches, household chemicals, and acid-based cleaners. If this happens, rinse and wipe dry quickly.
- **Salt, mustard, and mayonnaise** can cause pitting if left on the steel sink surface. If spilled, clean and rinse immediately.
- **A high iron content** in the water (hard water) may result in a brown or rust-colored stained appearance. If noticed, dry towel sink after each use.

- **Do not use rubber mats** in the sink bowl. Material trapped under mats can complicate cleaning.

NOTE: Improper use may damage this product and void the warranty.

HIGH GLOSS AND MATTE CLEANING

High gloss matte surfaces boast great aesthetic appeal, but require special care to preserve their qualities during their lifespan.

A good range for relative humidity to ensure the quality of the finish is between 30-60%. Condensation/humidity should be controlled as much as possible by keeping good circulation within the coach.

When cleaning high gloss surfaces, use a microfiber cloth and non-solvent based surface cleaner. Dust can be cleaned with a moist soft cloth or duster; smudges, grease and tacky residues can be removed with a microfiber cloth moistened with some mild detergent. Solvents should never be used as they might lead to staining and/or discoloration.

Paper based decors (finish foil) should be dried thoroughly with a dry cloth after cleaning. Failure to do so might lead to the surface becoming wrinkled and in the long term, peeling.

- Provide ventilation and/or reduce relative humidity of air by, particularly in moisture-prone period of the year (especially winter time) and when the moisture is produced in the van (cooking, shower).
- Reduce the amount of moisture produced in the vehicle.
- Increase heating to raise the temperature of the air and the cold surfaces.
- Oils/grease/stains clean with a moisten soft cloth with mild detergent, if the surface is wet after cleaning, dry it.
- Dust/residues clean with a moist soft cloth, dry the surface after cleaning.
- Horizontal surfaces clean any spills and residues right away.

- DO NOT use detergents or chemical cleaners on your furniture this may damage the finish.
- DO NOT drop the pieces
- DO NOT expose the furniture to extreme hot, cold, rain, humidity or salinity.
- DO NOT leave surfaces wet with beads of water standing.
- DO NOT use solvents for cleaning
- DO NOT use abrasive cleaning tools.

On dry days open some windows to allow humid air to ventilate out of the vehicle. It is better to open a few windows, as it helps the air to move throughout the motorhome. One window open wide may not be as effective. Try to do this as often as possible (at least once a week), but keep windows closed on wet days as damp air may increase indoor humidity.

High temperatures can also damage surfaces of your furniture. Protect them with protective table pads or place-mats when utilizing extremely hot utensils or dishes.

RANGE AND REFRIGERATOR

For care and appearance maintenance of the range and refrigerator, refer to the appliance manufacturer's operation and maintenance manuals included in your InfoCase.

VINYL FLOORING

Care and Maintenance

You can easily maintain the beauty of your vinyl flooring with little effort, by following these recommendations:

- Sweep or vacuum floor daily (use a vacuum without a beater bar head.) Remove loose dirt with a soft brush or Swiffer® type product.
- For more intense cleaning, use a non-abrasive cleanser, such as Mr. Clean®. Rinse with clean water.

NOTE: Floor cleaners containing waxes, brighteners, or gloss agents are not recommended.

SECTION 10 – MAINTENANCE AND STORAGE

- Regular cleaning with solvent-based chemicals may adversely affect the topcoat performance.
- Do not use undiluted bleach or leave a dilution of bleach on the floor for longer than one hour.
- Vinyl flooring is extremely durable and long lasting. It is normal for the floor to show some denting and dimpling where furniture sets due to the soft nature of the material. The dents are not permanent and will come out over time.

Maintenance Tips

- Install protection (such as pads or casters) on furniture with legs or sharp edges. This protection should not contain bitumen, which may cause brown stains.

NOTE: Faulty pads and casters should be removed and replaced.

- Burning cigarettes and matches can cause damage to the flooring.
- Use doormats (that do not contain bitumen) to keep out most of the dirt and dust.
- Remove spills immediately with a damp cloth, followed by rinsing with clean water.
- The use of stiletto heels is not recommended, as they may cause permanent damage to the flooring.
- Protect flooring from prolonged direct sunlight exposure.

Treatment of Stains

Acids, alkali, alcoholic beverages, coffee, soft drinks, ketchup, fruit, fruit juices, food, vegetables, mustard, ink, and iodine:

- Remove the stain with lukewarm water and a cloth or sponge. If necessary, clean with a soft nylon pad and non-abrasive mild detergent or resilient floor cleaner.

Heel marks:

- Clean as soon as possible with a soft nylon pad and non-abrasive mild detergent or resilient floor cleaner.

Asphalt, candle grease, chewing gum, fat, oil, tar, and shoe polish:

- Gently remove with a blunt instrument and treat with a soft nylon pad and non-abrasive floor cleaner.

Lacquer and nail polish:

- Remove as soon as possible. Do not allow to dry. If necessary, apply nail polish thinner (sparingly) to remove any residue.

Corrosion, paint, and grass stains:

- Treat as soon as possible with a soft nylon pad and non-abrasive mild detergent or resilient floor cleaner.

Varnish, oil paint, and solvents:

- Blot up as soon as possible. Do not rub, as this will only spread material further across the surface. Carefully treat with a mild cleanser. When dry, carefully peel the stain off. MEK may be used sparingly, if necessary. Rinse immediately with clean water.

Pet stains:

- Treat with lukewarm water. If stain remains visible, clean with a soft nylon pad and non-abrasive resilient floor cleaner.

BATHROOM

Toilet

For instructions on the care of your toilet, refer to the information in your InfoCase.

Tub and Shower Walls

The tub and shower walls in the bathroom should be cleaned with mild soap and warm water. Do not use an abrasive cleaner on the shower walls and tub, as scratching and discoloration may occur. Stubborn stains may be removed with an automotive-type cleanser.

Lavatory Sink (Model 59GL)

The lavatory sink is made of the same material as the galley sink. See Galley Sink - Care and Cleaning Instructions.

(Model 59KL)

The sink in the bathroom should be cleaned with mild soap and warm water. Do not use an abrasive cleaner on the sink, as scratching and discoloration may occur. Stubborn stains may be removed with an automotive-type cleanser.

DOORS AND MIRRORS

Door locks and hinges should be lubricated periodically with powdered graphite to ensure trouble-free operation and to protect against freeze-up.

Use care when removing ice from the mirrors to protect the reflective surfaces.

WINDOWS

For Acrylic Windows:

To avoid damage to the acrylic surface, care should be taken when selecting cleaning agents. Using chemicals, solvents, or abrasive cleaners on acrylic windows could damage the window surface.

<p>NOTICE</p>
<p>Do not use an ice scraper on acrylic windows. Damage to the windows may occur.</p>

Refer to the manufacturer's information located in your InfoCase for further information on caring for your acrylic windows.

For Glass Windows:

Use care when removing ice or frost from the windows. Always use a plastic ice scraper, never one made of metal.

Glass windows may be periodically cleaned with a good quality glass cleaner or mild soap solution using a soft cloth.

**VEHICLE STORAGE –
PREPARATION**

Properly preparing your vehicle for storage will lessen the possibility of damage to your vehicle. Prepare the motorhome for vacancy just as you would if you were leaving your house for an extended period.

Clean and Prep Motorhome for Storage

1. Turn off the propane gas tank.
2. Turn the furnace thermostat switch OFF.
3. **Remove all foods and items that may cause odors from cabinets and refrigerator.**
4. Clean and defrost the refrigerator. Prop the door open slightly to allow any odors to dissipate. Place an open box of baking soda inside the refrigerator to help absorb odors.
5. **Fully charge the chassis battery. Batteries must have at least 80% charge to survive freezing temperatures and long period of non-use.** We recommend that you connect a battery charger once a month during long-term storage periods to maintain battery charge and to avoid sulfating.
6. See “Pure³ DC System (Volta)” in *Section 6 - Electrical* for instructions on storage of Pure³ battery system.
7. Have the vehicle chassis completely serviced and lubricated. Be sure radiator antifreeze protection level is sufficient for the lowest anticipated temperatures.
See the chassis manual located in your InfoCase for further information.
8. Wash and wax the motorhome.
9. Inspect all seams and seals around doors, windows, vents, and any other joints. Replace or repair any that are damaged. Sealing materials and compounds can be purchased from your dealer. Badly damaged weather seals may need to be replaced by your dealer.
10. Close all windows and roof vents. Protect all appliance vent openings from contamination by animals or insects (e.g. bird nest, wasp nests, etc.)

SECTION 10 – MAINTENANCE AND STORAGE

11. Lubricate all door hinges and locks.
12. Clean the interior of the motorhome. Dirt and stains are more easily removed when fresh.
13. Follow “Vehicle - Leaving in Storage” suggestion in chassis owner’s manual included in your InfoCase.

If you are storing your vehicle through the winter, or in cold climates, extra preparations must be made to protect equipment and systems that can be damaged by freezing temperatures. See “Winterizing Procedure” in *Section 7 - Plumbing*.

VEHICLE STORAGE – REMOVAL

1. Completely air out the motorhome.
2. Have the entire LP gas system checked for leaks.
3. Check window operation.
4. Check cabinet and door hinges. Lubricate with penetrating oil, if necessary.
5. Close all faucets and drain valves that are open.
6. Add a few gallons of water to the fresh water tank and turn on the water pump to check for leaks, especially at fittings.
7. Open all faucets in turn to release trapped air and check to be sure faucet washers have not hardened during storage.
8. Sanitize the water system as outlined under *Disinfecting the Fresh Water System* in the Plumbing section, then flush the waterlines thoroughly with fresh water.
9. After flushing fresh waterlines, install a new water filter cartridge on the galley sink water filter. See appropriate filter installation instructions in Plumbing section.

NOTE: Always purge a new filter with clean running water before using. See filter manufacturer’s directions included with the filter cartridge.

10. Check the toilet for proper operation.

11. Add water to the holding tank using the toilet flush pedal and galley sink faucet. Check to be sure dump valves seal tightly.
12. Check around all appliances for obstructions and ensure that all vent openings are clear.
13. Start refrigerator and check for proper cooling.
14. Clean wall and counter surfaces.
15. Replace battery, if necessary, and check out electrical system to make sure all lights and electrical components operate.
16. Check tires for proper cold inflation pressure. See “Vehicle Certification Label” in *Section 1 - Introduction*.
17. After washing accumulated winter grime from the vehicle, it is important to carefully inspect the seams and sealants for separation or cracks that may have appeared around the window frames, vents, and any other joints. See *Sealants – Inspection and General Information* at the beginning of this section. Resealing is quite simple and the material is quickly and easily applied. Appropriate compounds are available from your dealer. See the *Sealants – Recommended Application* page in the Supplement Manual provided in your InfoCase. Also inspect weather seals around doors, etc., and if necessary, have a dealer replace immediately.

CHASSIS SERVICE AND MAINTENANCE

Consult the appropriate sections in the chassis manual for specific information regarding operating safety, service recommendations, and maintenance schedules for the chassis section of your vehicle.

**SECTION 10 –
MAINTENANCE AND STORAGE**

MOTORHOME MAINTENANCE CHART

These recommendations apply for normal recreational use. Heavy duty or full-time use may require more frequent maintenance intervals.

Always use specified sections or manufacturer's guide for further information and instructions.	Before Each Use	Weekly	Monthly	Every 3 Months	Every 6 Months	Every Year	As Necessary
Propane Gas System							
Have propane gas system checked for leaks						◆	◆
Pressure regulator - inspect and adjust if needed						◆	
Check propane tank condition, mounting, and fittings						◆	
Electrical System							
Check battery condition meter	◆						
Check battery connections			◆				
Check 12V fuses and 120V breakers							◆
Check GFCI receptacles			◆				
Generator							
Visually inspect generator	◆						
See generator manufacturer's maintenance guide							◆
Plumbing System							
Sanitize plumbing system							◆
Winterize plumbing system							◆
Clean water pump strainer filter						◆	◆
Exterior							
Clean roof				◆			◆
Clean sidewalls			◆				◆
Clean windows							◆
Flush underside of vehicle				◆			◆

SECTION 10 – MAINTENANCE AND STORAGE

MOTORHOME MAINTENANCE CHART

These recommendations apply for normal recreational use. Heavy duty or full-time use may require more frequent maintenance intervals.

Always use specified sections or manufacturer's guide for further information and instructions.	Before Each Use	Weekly	Monthly	Every 3 Months	Every 6 Months	Every Year	As Necessary
Safety Equipment							
Check operation of the following items:							
Headlights, Taillights, and Marker Lights	◆		◆				
Turn Signals	◆		◆				
Horn	◆		◆				
Hazard Warning Flashers	◆		◆				
Windshield Wipers and Washers	◆		◆				
Headlight Alignment							◆
Fire Extinguisher - check charge indicator	◆		◆				
Smoke Alarm - test operation *	◆		◆				
Carbon Monoxide Alarm - test operation *	◆		◆				
Propane Gas Leak Detector - test operation (*replace battery if needed)	◆		◆				
Appliances							
Heating System							
See heating system manufacturer's maintenance guide							◆
Inspect and clean exterior vent	◆						◆
Refrigerator							
See refrigerator manufacturer's maintenance guide							◆
Air Conditioner							
See A/C manufacturer's maintenance guide							◆
Inspect for exterior damage				◆			◆
Check and clean filter			◆				
Range Top							
See range manufacturer's maintenance guide							◆

MOTORHOME MAINTENANCE CHART

These recommendations apply for normal recreational use. Heavy duty or full-time use may require more frequent maintenance intervals.

Always use specified sections or manufacturer's guide for further information and instructions.	Before Each Use	Weekly	Monthly	Every 3 Months	Every 6 Months	Every Year	As Necessary
Sealants							
Inspect (see "Sealants" at the beginning of this section for proper inspection technique)					◆		◆
Replace (see "Sealant Call-out Sheet in the supplement manual provided in your InfoCase)							◆
Frame and Chassis							
Follow chassis manufacturer's maintenance guide (refer to chassis manual)							◆
Inspect hitch receiver (if towing)	◆						
Tires							
Check and adjust air pressure	◆						◆
Check tread wear	◆						◆
Check front end alignment and adjust if needed							◆
Miscellaneous							
Lubricate locks, hinges, latches						◆	◆

SECTION 11 – MISCELLANEOUS

LOADING THE VEHICLE

NOTE: Your motorhome's load capacity is designated by weight, not by volume, so you cannot necessarily use all available space when loading your motorhome.

- Store or secure all loose items inside the motorhome before traveling. Possible overlooked items such as canned goods or small appliances on the countertop, cooking pans on the range, or free-standing furniture items can become dangerous projectiles during a sudden stop or evasive maneuver.
- Be aware of GVWR, GAWR, and individual load limit on each tire or set of duals.

When loading the vehicle, distribute the cargo load equally so that you do not exceed either the Front or Rear Gross Axle Weight Rating (GAWR) or the Gross Vehicle Weight Rating (GVWR). The Gross Axle Weight Rating (GAWR) means the weight value specified by the chassis manufacturer as the load carrying capacity of a single axle system as measured at the tire-to-ground interfaces. This is the total weight a given axle is capable of carrying. Each axle has its own rating.

Have your vehicle weighed to determine the proper load distribution for your vehicle. Also distribute cargo side-to-side so the weight on each tire or dual set does not exceed one half of the GAWR for either axle.

For example, if the Front GAWR is 6,000 lbs., there should be no more than 3,000 lbs. on each tire. (If the left side weighs 3,100 lbs. and the right side weighs 2,700 lbs., at least 100 lbs. of the load must be shifted from the left side to the right side.) The GVWR is listed on the Vehicle Certification Label. (See sample in *Section 1 - Introduction*).

The GCWR (Gross Combination Weight Rating) means the maximum allowable loaded weight of this motorhome and any towed trailer or towed vehicle.

NOTE: We recommend that you dump all holding tanks before traveling to avoid carrying unnecessary weight.

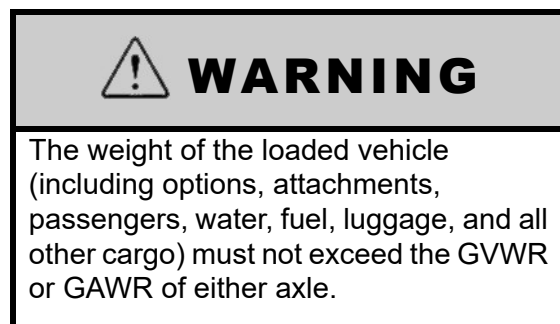

WEIGHING YOUR LOADED VEHICLE

To check the weight of your fully loaded motorhome, locate a commercial weighing scale that is capable of weighing large trucks.

NOTE: Sales literature may give approximate or standard weights. Your actual motorhome weight may differ based on added factory and/or dealer options.

Loading

Load your vehicle completely as if you were going on a long trip with everything you would carry, including food, clothing, bedding, lawn chairs, etc., a full fuel tank, full propane tank, and a partial tank of fresh water, but empty holding tanks. Remember, tongue weight must be included in the GVWR.

Finding a Scale

In urban areas, the most common places to find a public access scale are commercial truck stops. In rural areas, most grain storage elevators have scales available. Most scales charge a nominal fee for weighing a vehicle.

SECTION 11 – MISCELLANEOUS

Weighing

There is typically a scale operator to direct you, but the basic routine is to take three separate weights - front axle, whole vehicle, and rear axle.

You will first drive only your front wheels onto the scale pad, then drive ahead so that the whole vehicle is on the scale, then finally pull off until just the rear wheels are on the pad.

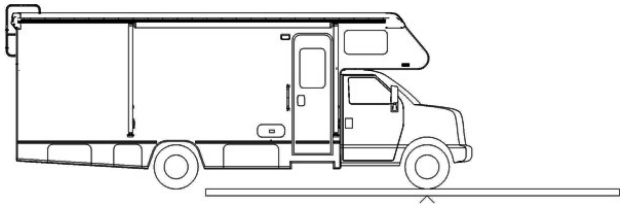

Front GAWR (Front Axle Only)

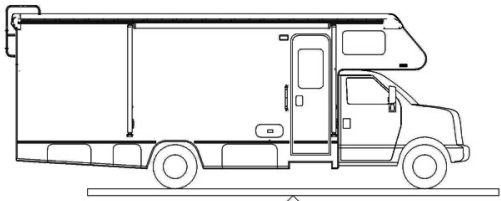

GVWR - Whole Vehicle (All Axles)

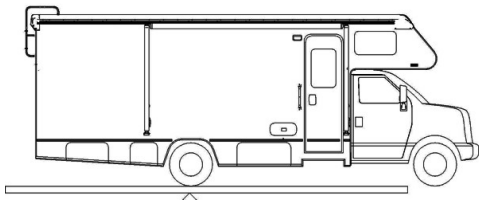

Rear GAWR (Rear Axle Only)

You will receive a weight “ticket” that states your current Front Gross Axle Weight, Rear Gross Axle Weight, and Gross Vehicle Weight. You can compare these weights to the weight ratings listed on your Vehicle Certification Label to use as a guideline for future loading limits and weight distribution.

The gross weight of the vehicle must not exceed the Gross Vehicle Weight Rating (GVWR) specified on the Vehicle Certification Label. The front and rear axle weight also should

not exceed the corresponding Axle Weight Rating specified on the Vehicle Certification Label.

Corner Weighing (Side-to-Side)

The most accurate method of weighing a motorhome is to weigh each “corner” of the motorhome separately (single L/R front wheels or L/R rear dual sets.) This method will help you determine how to distribute your cargo to avoid overloading, especially on tires.

To determine the weight distribution on each tire or dual set, you will need to find a scale capable weighing side-to-side, or all four “corners” of the vehicle separately.

A truck scale may be used if the ground is level with the scale surface and the scale has clearance to drive one side of the motorhome onto the scale as shown.

Drive the motorhome on the level area next to the scale and straddle the scale so that only one side of the motorhome will be on the scale pad.

NOTE: Wind and precipitation can also cause weight inaccuracies.

Pull only the right front wheel onto the scale pad as shown.



Weighing Right Front Corner

When the front wheel has been weighed, pull the motorhome straight ahead until only the right rear wheel/dual set is on the scale pad as shown.



Weighing Right Rear Corner

Now, turn the motorhome around and repeat the process for the other side.

The load on each wheel or dual-wheel set should not exceed one-half of the corresponding GAWR. For example, if the GAWR for the rear axle is 12,000 lbs., then the load on each rear dual set (left rear duals or right rear duals) should not exceed 6,000 lbs.

Tires must be filled to the recommended air pressure for the highest loaded tire set on that axle. For example, on the rear axle, if the left side weighs more than the right, fill the left tires to the pressure required for that weight, then fill the right tires to the same pressure as the left ones.

If your actual weight is considerably less than GAWR, you may be able to lower your tire pressure. See a tire dealer for a load/pressure chart.

NOTE: The Hitch Load from a Towed Vehicle or carrier box must also be counted on the Rear GAWR and subtracted from the rear axle cargo capacity.

Be aware that hitch load can affect handling characteristics. The more weight on the hitch, the lighter the front end will feel at the steering wheel.

CAR OR TRAILER TOWING

Hitch Capacity*

3,500 lbs. max.

Tongue Weight*

350 lbs. max.

The factory installed towing hitch on this motorhome is capable of pulling 3,500 lbs. load (max.), however, the vertical (tongue) weight may vary according to chassis and model combinations (*see label on hitch). Towing capacity may be less than hitch rating.

When towing a trailer or vehicle, do not exceed either the GVWR, the rear axle GAWR, or the chassis GCWR (the combined loaded weight of the motorhome and the towed vehicle).

See preceding items “Loading the Vehicle” and “Weighing Your Loaded Vehicle” for explanation of weight ratings.

Because of individual vehicle use and loading habits, we recommend weighing the vehicle while fully loaded to avoid exceeding any of the listed Gross Weight Ratings. See “Vehicle Certification Label” in the Introduction section for information on gross weight ratings.

Towing will affect vehicle handling, durability, and fuel economy. Exceeding any of the listed Gross Weight Ratings will result in unacceptable overall vehicle performance. Maximum safety and satisfaction when towing depends on proper use of correct equipment.

When towing a vehicle behind your motorhome, the tow bar should be level or pointing slightly upward towards the tow vehicle.

When coupling the vehicle tow bar to the Factory Receiver Hitch using a “drop receiver” or a conventional “ball mount” (commonly referred to as a “stinger” or a “draw bar”), do not exceed a 4” drop, nor one that the centerline of the hitch pin to the centerline of the ball exceeds 8”. See the following Hitch Assembly illustration.

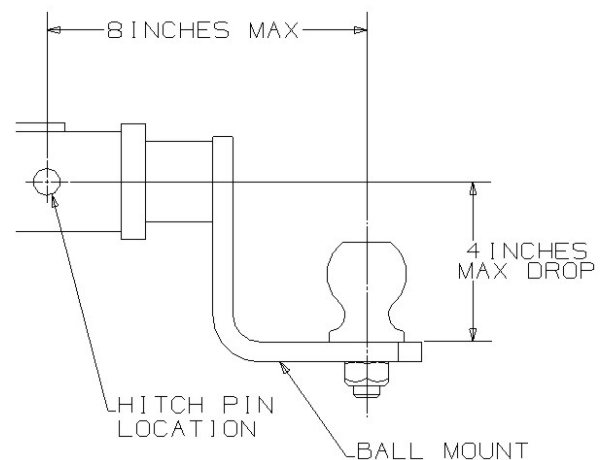

Hitch Assembly

If a towing “brake system” is required, we recommend that a “modulated” towed vehicle braking device be installed. This means that when the motorhome brakes are applied, whether hard or soft, a mirror effect occurs in the braking

SECTION 11 – MISCELLANEOUS

of the towed vehicle. In other words, the more force applied to the motorhome brakes, the more force will be applied to the rear vehicle's braking system.

We do not recommend the usage of a “surge-style” braking device. The usage of a surge brake (especially when coupled with a hitch ball located outside our recommended limits) places excessive stress on the hitch. This abuse of the ball mount and the hitch may cause premature hitch assembly failure.

Finally, do not forget to consider the actual tongue weight. This should not exceed the stated hitch vertical load for your vehicle. This weight is typically defined as the tongue weight of a towed vehicle hitch, boat trailer tongue weight, or a receiver-mounted carrier rack.

Check state regulations on trailer weight and trailer brake requirements to be sure you select the right equipment before towing.

Before descending a steep or long grade when towing a trailer, reduce speed and shift into a lower gear to control vehicle speed. Avoid prolonged or frequent application of brakes which could cause overheating and brake failure.



WARNING

For safe towing and vehicle handling, maintain proper trailer weight distribution. The total weight of the motorhome and the vehicle towed must not exceed the Gross Combined Vehicle Weight rating. See the “Body and Chassis Specification” chart in the Introduction section.

NOTICE

Exceeding any of the recommended gross vehicle weight ratings may result in vehicle damage. Do not install a frame equalizing-type hitch on your vehicle.

TRAILER WIRING CONNECTOR

Your motorhome is pre-wired for trailer or car towing lights with a 4-pin wiring connector.

The “pigtail” assembly with the (car/trailer end) connector plug should be wired by a qualified technician.

The trailer brake controller connector is located to the left of the steering column.

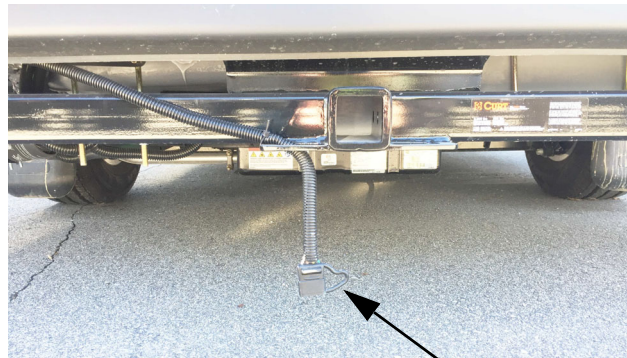

• 4-pin socket

Further Information

Refer to the chassis manufacturer's user guide provided in your InfoCase for further instructions.

TOWING GUIDELINES

Gross Vehicle Weight Rating (GVWR)

This is the maximum allowable weight of the fully loaded vehicle. Included are fuel, water, LP, passengers, cargo, tools, and optional equipment installed by the motorhome manufacturer, dealer, or owner. This value is found on the VIN label, typically placed near the driver position.

Gross Axle Weight Rating (GAWR)

This is the total weight a given axle is capable of carrying, measured at the ground. Each axle has its own rating. These values are also found on the Vehicle Certification Label: front and rear.

Gross Combination Weight Rating (GCWR)

This is the maximum allowable weight of the motorhome and loaded trailer, including the items noted in GVWR above. For purposes of this definition, the “trailer” can be a trailer, a vehicle towed on a dolly, or a vehicle towed by means of a tow bar. GCWR is typically specified based on durability and performance of the tow vehicle drive train: engine and cooling systems, transmission, drive line, drive axle, and others. The tow vehicle brakes may be rated for operation at GVWR, not GCWR.

*NOTE: State or provincial laws/regulations may require the “trailer” to be equipped with brakes that are activated when the motorhome brakes are applied. **The user is responsible to know and understand the laws of the state or province being traveled.** The Department of Transportation in a given state or province should be able to provide specific information.*

Hitch Ratings

SAE Standard J684 defines:

- Class 1 trailers as “GVWR not to exceed 2,000 lbs”.
- Class 2 trailers as “GVWR over 2,000 lbs. and not to exceed 3,500 lbs. GVWR”.
- Class 3 trailers as “GVWR over 3,500 lbs. and not to exceed 5,000 lbs. GVWR”.
- Class 4 trailers as “GVWR over 5,000 lbs. and not to exceed 10,000 lbs. GVWR”.

Hitches are to be permanently marked with “Maximum trailer GVWR to be drawn” and “Maximum vertical tongue weight to be imposed.” The SAE standard does not specify a vertical load rating.

Traditionally, hitches are labeled 3,500/350 as Class 2, 5,000/500 as Class 3, and 10,000/1,000 as Class 4. The vertical tongue load value of 10 percent of drawn rating comes from the collective experience that 10 percent is the minimum value that provides stable towing of a trailer.

NOTE: Some Winnebago Industries® models equipped with a Class 3 hitch may have a label limiting vertical tongue load to 350 lbs. Some Winnebago Industries models equipped with a Class IV hitch have a label limiting vertical tongue load to 500 lbs. On a 228" wheelbase, a 500-lb. load on a hitch 11' from the rear axle will apply about 800 lbs. at the axle.

The user must verify that the hitch equipment being used is adequate for the application.

WINDOW – SLIDING DOOR

–If Equipped

NOTICE

Before opening or closing the passenger’s side sliding door, close and latch window before the door is operated or damage to the window may occur.

WINDOWS

(Typical View – Your motorhome may differ in appearance)

Push-Out Windows

–If Equipped

The bedroom and lounge windows are secured by safety latches at the sides and bottoms of each window.

To open window, release all window latches and push open.

1. Side Latches - Pull down toward bottom of window frame.
2. Bottom Latch - Pull toward the left-hand side of the window frame.
3. Push window open.

SECTION 11 – MISCELLANEOUS



-Typical View

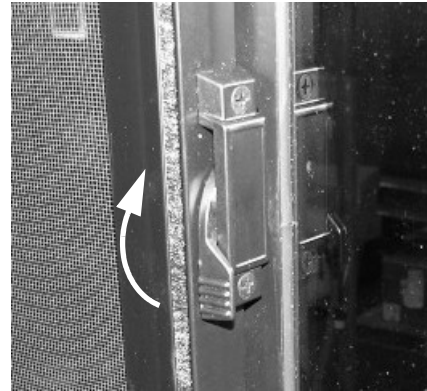

-Typical View

Propping the Windows Open

The bedroom and lounge windows are featured with prop rods on each side of the window. These rods have two notches to prop your windows open at. Push window open slowly and stop at the preferred notch setting.

Closing the Windows

To close window, extend all the way out (past the second notch setting) and the window will retract. Grab one of the window latches and pull window toward you and secure all three latches into locked position.

Horizontal Slider Windows

-If Equipped

Swing the latch handle straight out or up (depending on the style of window). Grasp the sliding window edge frame and slide the window to the side. Ensure the latch is open before trying to slide the window closed.

POWER ROOF VENTILATOR

The Power Roof Ventilator features a rain cover, electric lift, and thermostat operation with exhaust airflow.

The vent is controlled by a switch on the wall, remote, or keypad controls on the fan.

NOTE: In event of power failure, the ventilator dome may be opened or closed manually using the Dome Crank knob.

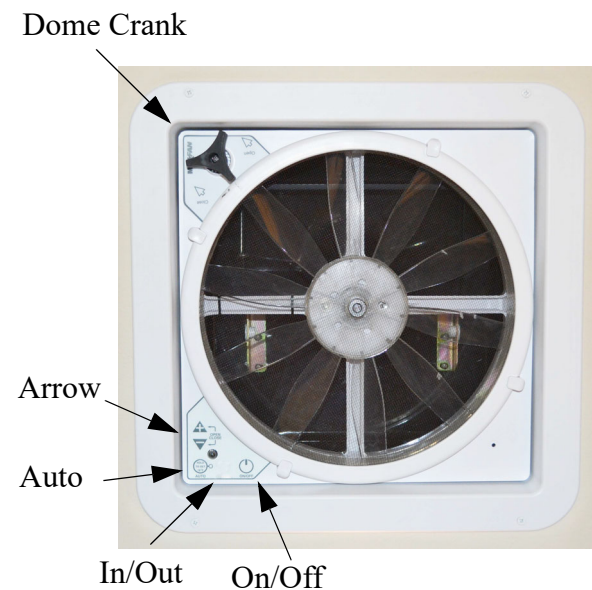

Power Roof Ventilator

- **ON/OFF** – Press to turn the fan on or off. The vent lid will open automatically when the fan is turned on and close when the fan is turned off.

- **IN/OUT** – Press to reverse the direction of the fan. The fan will slow down and pause for two (2) seconds before resuming operation in the opposite direction.
- **AUTO** – Press to enter Auto Mode. You will hear three (3) quick beeps to confirm the fan is in Auto Mode. To exit Auto Mode, press the On/Off button.
- **ARROW** – In Auto Mode press the +/- arrow buttons to adjust thermostat temperature up or down. Press the +/- arrow buttons at the same time to open or close the vent lid.

NOTE: For best results, close all other roof vents, windows, and doors, then open one (1) window the farthest distance from the roof ventilator. The fan speed selector allows you to control the amount of circulation you need at any time.

Further Information

See the power ventilator manufacturer’s operating instructions supplied in your InfoCase for further instructions, care, and cleaning information.

POWER ROOF VENTILATOR (Bath)

Fan Lift Bar



Fan Power Switch

Power Roof Ventilator

To Operate Ceiling Ventilator

1. To open the ventilator dome, push upwards on the Fan Lift Bar.

2. Press the Fan Power Switch to operate.
3. When finished using the roof ventilator, press the Fan Power Switch to stop operation.
4. Pull the Fan Lift Bar down to close dome.

AWNING – POWER WITH BLUETOOTH

The Power Awning control switches and Awning Light switch is located near the sliding entrance door. Turn the power switch to “ON” to enable the controls to extend and retract the awning. Make sure the switch is in the “OFF” position while the vehicle is moving.



Power Awning control switches and Awning Light Switch
(Located near sliding entrance door)
-Typical View

⚠ CAUTION

Pinch Hazard. Ensure there are no people who could be harmed or objects that can be damaged. Failure to heed this warning could result in severe injury and/or property damage.

Operating the Awning

- Press the Patio Awning switch OUT (to extend) or IN (to retract).

SECTION 11 – MISCELLANEOUS

Ignition Lockout System

The ignition lockout system will disable the extend function while the vehicle ignition key is in the On position, and when the Pure3 auto start is enabled. With this feature, the Awning will only extend when the vehicle ignition key is in the Off position. The Awning can retract anytime regardless of the ignition key position.

Bluetooth Feature

The awning is equipped with a bluetooth feature that allows the user to extend and retract the awning. The app can be downloaded to your smart-phone via the appstore.

Awning Motion Sensor

The awning has a wind motion sensor that is powered by batteries. When the batteries die, there will be a beeping sound inside the coach indicating the need to replace them. The batteries are located in the lead rail on the motor side of the awning.

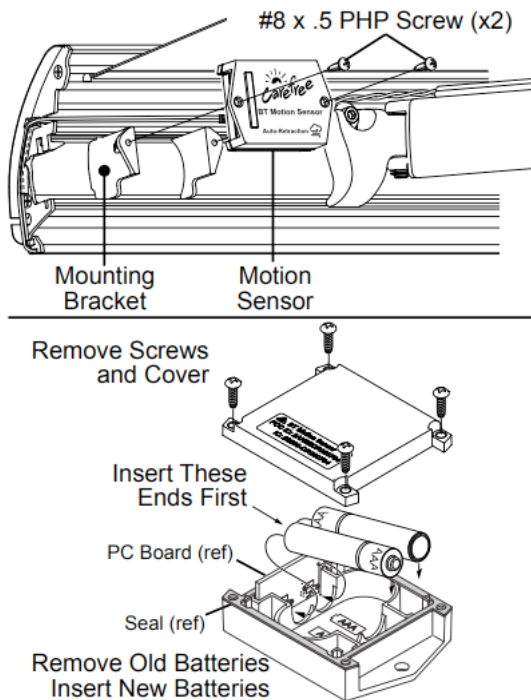

Awning motion sensor battery replacement
(see below for details).
-Typical View

To replace the batteries:

1. Remove the screws and the rear cover from the module.
2. Remove the two batteries.
3. Make sure that the contact tabs are clean and bent out for best contact.
4. Insert new batteries. Match the new battery orientation with the old batteries.
Tip: Place the battery end next to the PC board first then swivel the other end into the case. This will set the batteries firmly into the case.
5. Check that the seal is in place and flat, and then attach the rear cover with the screws removed previously.
6. To Test: Hold the sensor vertically with the Carefree logo upright, repeatedly move the sensor vertically up and down to simulate a brisk wind. The awning should retract. If the awning does not retract, it may be necessary to pair the sensor to the BT12 Module. Follow the steps below.
7. After the module works correctly, install the module on the bracket.

NOTE: Bracket will be unattached in the lead rail. When the module is screwed onto the bracket it will tighten and bind in the lead rail.

Pairing the motion sensor may be necessary for replacements and upgrades, the steps are as follows:

1. Extend the awning using the switches.
2. Place the awning in pairing mode.
3. Insert the batteries into the module.
4. Hold the motion sensor next to the control module. The device should pair within 90 seconds.
5. To Test: Hold the sensor vertically with the Carefree logo upright, repeatedly move the sensor vertically up and down to simulate a brisk wind. The awning should retract.
6. Mount the module.

Further Information

For complete operating instructions, features, safety precautions, and maintenance care, refer to the Awning manufacturer's user guide provided in your InfoCase.

ACCENT LED RUNNING BOARD LIGHTS

-If Equipped

Your motorhome may be equipped with passenger and driver side running board accent lights. The LED Light Strips are disabled when the ignition key is turned on (engine running).



Accent LED Light Strips
(Located on passenger side running board)
-Typical View



Accent LED Light Strips
(Located on driver side running board)
-Typical View

The Front AUX switch (located near the sliding entrance door) operates the LED Light Strips.



Accent LED Running Board Light Switch
(Located near sliding entrance door)
-Typical View

SCREEN DOOR

NOTE: Screen door must be retracted before closing sliding door or damage will occur.

To Extend Screen Door

- Pull door from center of vertical bar.



-Typical View

- Lubricate periodically with PTFE spray.
- Clear debris from the threshold track when needed.

SECTION 11 – MISCELLANEOUS

BIKE RACK

–If Equipped

Your motorhome may be supplied with a Bike Rack mounted on the rear passenger side door.

1. Lift bike stabilizers upward.
2. Release bike rack retention brackets by pulling outward. Lower the bike rack.
3. To extend the bike rack rails, loosen the rail lock knobs. Pull to extend bike rack rails toward the driver side of motorhome. Tighten the lock knobs to secure bike rack rails.
4. Lift bike into place on the rails. Fasten bike to rack using the locking straps and bike stabilizer.
5. Ensure bikes are secure.
6. Reverse steps to store bike rack.

**Maximum Capacity of Bike Rack:
100 lbs.**

• Bike Stabilizers

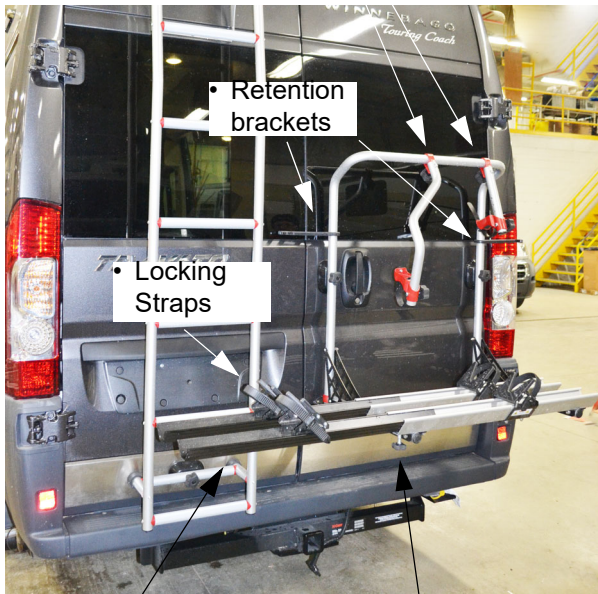

• Bike Rack Rails

• Rail Lock Knobs

Bike Rack
(shown in down position)

LADDER

–If Equipped



WARNING

STAY OFF ROOF. Surface may be slippery. Falling could result in death or serious injury.

Your motorhome may be supplied with a Ladder mounted on the rear driver side door.

The ladder on your motorhome is provided for limited access to the roof. The ladder must be removed from the stored position and mounted on the roof rail for use.

Walking or working on the roof should be left up to qualified service personnel using proper safety equipment in a safe environment. You should only walk or work on the roof if you are qualified and have created a safe environment.

For your safety, it is not recommend that you store or carry items on the roof.

Note: The ladder must not be used in the stored position, as this may cause damage. The ladder can only be used when it is properly seated on the ladder roof rail.

Before Using the Ladder

- **Inspect the ladder** to make sure it is not damaged. Never use a damaged ladder.
- **Keep the rungs of the ladder clean and dry** while in use. Never use the ladder when it is raining, snowing or icy. The rungs can become slippery. Do not step onto the rungs if the rungs are wet, or if your shoes are wet or carry mud or debris that could result in a loss of footing.
- **Never ignore warning labels** or weight limits defined on your ladder. The following warning label is located on or near the ladder:

 **WARNING**

Do not exceed 225 lbs. maximum weight capacity.
Misuse of ladder could result in death or serious injury.
See Operators Manual before using ladder.

- **Maximum Capacity: 225 lbs.**
- **Do not overload.** Ladder is intended for one person.
- **Make sure you are physically capable** to safely use the ladder. Strength, flexibility and stability are required.
- **Be aware that the vehicle may sway** as you climb the ladder. Do not use the ladder in high winds.
- **As you climb the ladder,** grasp the side rails firmly and always use both hands. Keep your body centered between the side rails. Do not over-reach.
- **Always store** the ladder extension when not in use.
- **Never allow children** on the ladder.
- **Do not transport items** anchored to the ladder. You could damage the ladder.

To Remove Ladder from Stored Position

1. Locate the ladder lock knob at the bottom of the ladder in the storage position. Unlock and unscrew ladder lock knob to remove.

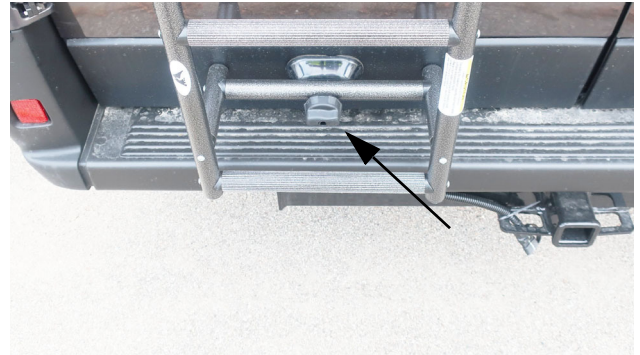

Ladder lock knob

Swing out the protective cover to access keyhole. When the knob is unlocked it can be unscrewed, releasing the lower portion of the ladder.

-Typical View

2. Lift ladder from storage rungs.



Ladder Storage Rungs
-Typical View

3. Mount ladder on driver side ladder roof rail. The ladder may be positioned at any point on the ladder roof rail.

SECTION 11 – MISCELLANEOUS



Shown with Ladder properly mounted on rail at driver side.
-Typical View

4. Reverse steps to store ladder.

LUGGAGE RACK

-If Equipped

Your motorhome may be supplied with a Luggage Rack mounted on the roof of the vehicle.

- **Maximum Capacity of Luggage Rack:**
200 lbs. evenly distributed over all roof rails.
Each roof rail will support 40 lbs. of weight.



WARNING

STAY OFF ROOF. Surface may be slippery. Falling could result in death or serious injury.

SHOWER CURTAIN PAWN MAGNETS

(Model 59KL)

Your motorhome may be supplied with five (5) pawn magnets (located inside the InfoCase) to hold the shower curtain away from your body by attaching them to the rear van steel door.



Pawn Magnet
(Located inside InfoCase)
-Typical View

EFFECTS OF PROLONGED OCCUPANCY

Your motorhome was designed primarily for recreational use and short-term occupancy. If you expect to occupy your motorhome for an extended period, be prepared to deal with condensation and humid conditions that may be encountered.

Humidity and Condensation

Moisture condensing on the inside of windows is a visible indication that there is too much humidity inside the motorhome. Excessive moisture can cause water stains or mildew, which can damage interior items such as upholstery and cabinets.

When you recognize the signs of excessive moisture and condensation in your motorhome, you should take immediate action to minimize their effects.

You can help reduce excessive moisture inside the motorhome by taking the following steps:

Ventilate with outside air

Partially open one or more windows and a roof vent to circulate outside air through the motorhome. In cold weather, this ventilation may increase use of the furnace, but it will greatly reduce the condensation inside the motorhome.

Minimize moisture released inside the motorhome

Run the ceiling vent fan while cooking and open a bath vent while bathing or showering to carry water vapor out of the motorhome. Avoid making steam from boiling water excessively or letting hot water run. Avoid bringing extra moisture into the motorhome by way of soaked clothing or snow on shoes. Do not hang-dry wet overcoats or clothing inside the motorhome.

INDEX

About this Manual	1-1
Accent LED Running Board Lights	11-9
Access Port (Roof)	8-4
Air Conditioner Filter	4-7
Air Conditioner/Heater – Automotive (Dash)	3-3
Audio/Video System Basic Operation	8-2
Audio/Video System Connection	8-3
Awning – Power with bluetooth	11-7
Bathroom	10-10
Battery Access	6-6
Bed – Deluxe Sleep System	9-3
Bed	9-2
Before Driving	1-2
Bike Rack	11-10
Cabinetry – Cleaning	10-7
Cable TV Connection	8-3
Car or Trailer Towing	11-3
Carbon Monoxide Alarm	2-5
Carbon Monoxide Warning	2-5
Chassis Battery Care	6-6
Chassis Service and Maintenance	10-12
Circuit Breakers – House 120-Volt AC	6-4
Circuit Breakers and Fuses	6-7
Cold Water Filter	7-4
Decorative Vinyl Wall Paneling – Cleaning	10-7
Dinette table	9-1
Dinette table (portable)	9-1
Disinfecting Your Fresh Water System	7-4
Doors and Mirrors	10-11
Driving Safety	2-2
Eco-hot system	7-2
Effects of Prolonged Occupancy	11-12
Electrical	2-6
Electrical Cautions	6-1
Electrical Outlets – House 120-Volt AC	6-5
Electrical System – House 120-Volt AC	6-1
Electrical System – House DC	6-5
Engine Cooling System	3-5
Engine Overheat	2-10
Exterior Automotive Paint Finish	10-2
Exterior Cable TV – 12V Connection	8-3
Exterior Graphic Care	10-4

Index

Exterior Lights	10-5
Exterior Shower/Wash Stations	7-8
Exterior utility light switch	7-2
Fire Extinguisher	2-6
Formaldehyde Information	2-8
Fresh Water System	7-1
Front Axle Tire Alignment	1-2
Fuel and Propane Gas	2-2
General Warnings	2-1
Ground Fault Circuit Interrupter	6-5
Hazard Warning Flashers	3-3
Headlight Alignment	1-2
Heating System – Furnace and Indirect Water Heating	4-6
High Gloss and matte cleaning	10-9
High performance wheels	3-6
Interior Soft Goods	10-5
Inverter/Charger Unit – 3600W	6-2
Jump Starting	2-10
Keys	3-3
Ladder	11-10
Lights	3-5
Loading	2-7
Loading the Vehicle	11-1
Luggage Rack	11-12
Maintenance	2-7
Microwave Oven	4-2
Microwave/Convection Oven	4-2
Mold, Moisture, and Your Motorhome	2-8
Motorhome Maintenance Chart	10-13
Occupant and Cargo Carrying Capacity Labels	1-3
OnePlace® Systems Monitor Panel	4-2
Owner and Vehicle Information	1-6
Plastic Parts – Cleaning	10-5
Power Center	6-3
Power Control System (PCS)	4-5
Power Cord – External (Detachable)	6-1
Power Roof Ventilator	11-6
Power Roof Ventilator	11-7
Pre-Delivery Inspection	1-2
Propane Accessory Connection	5-3
Propane Gas Leak Detector	2-4
Propane Gas Leaks	2-4
Propane Gas Pressure Regulator	5-5
Propane Gas Supply	5-1
Propane Gas Warnings and Precautions	5-4

Propane Vaporization in Cold Weather	5-6
Pure3 DC System (Volta)	6-9
Radio – In-Dash	3-5
Radio In-Dash/Rearview Monitor System	3-5
Range and Refrigerator	10-9
Range Top (Electric)	4-1
Refrigerator	4-1
Remote Keyless Entry	3-3
Reporting Safety Defects	1-2
Roadside Emergency	2-9
Roof	10-1
Roof Air Conditioning System WITH BLUETOOTH CONTROL	4-7
Roof and Ladders	2-7
Safe Use of the Propane Gas System	5-4
Safety Messages Used in this Manual	1-1
Screen Door	11-9
Sealants – Inspection and General Information	10-1
Seat Belts	3-2
Seats – Driver/Co-Pilot	3-1
Service and Assistance	1-2
Shower Curtain Pawn Magnets	11-12
Shower Valve pressure bleed-off	7-7
Sink – Lavatory	7-7
Sink – Stainless Steel	10-8
Sleeping Facilities	9-1
Smoke Alarm	2-6
Solar Charge Panel	4-4
Solid Surface Countertop – Corian®	10-8
Specifications and Capacities	1-5
Suspension Alignment and Tire Balance	3-6
Tables and Countertops	10-7
Tank Heaters	7-14
Tires	3-6
Toilet	7-8
Towing Guidelines	11-4
Trailer Wiring Connector	11-4
TV – (Swing-Out)	8-1
TV – Swivel	8-1
TV Antenna – Digital	8-2
TV Signal Amplifier	8-2
Undercarriage	10-1
Vehicle Certification Label	1-4
Vehicle Storage – Preparation	10-11
Vehicle Storage – Removal	10-12
Vinyl Flooring	10-9

Index

Waste Water System (Model 59GL)	7-8
Waste Water System (Model 59KL)	7-11
Water Pump	7-2
Water System Drain Locations	7-21
Waterline and Tank Drain Valves	7-14
Weighing Your Loaded Vehicle	11-1
Window – Sliding Door	11-5
Window Shades	9-4
Window Shades/Screens	9-4
Windows	10-11
Windows	11-5
Windshield Blinds	3-3
Winterizing Procedure	7-15
Wood Furniture and Cabinetry	9-5
